



Distributed for Chrom4 by:



GmbH
www.chrom4.com

ABOUT CHROM4

In April 2010, a group of independent distributors met to discuss the dynamic shift in the chromatography consumables market.

The group concluded that mergers and acquisitions in the chromatography consumables industry have limited the offerings available to the laboratory scientist.

These users of chromatography consumables and buyers of companies from small to large are faced with limited offerings, meaning less choice and less competitive pricing.

Aiming to provide more options and let local independent distributors operate on a more level playing field, the idea of a buying group was born.

This buying group would enable these local distributors, who are specialized experts in chromatography, to compete with world-class quality products, yet maintaining a strong relationship with the customer. The realization of this idea is Chrom4.

Global companies, who purchase for many worldwide locations can benefit from our distributors by receiving group pricing and maintain the same quality with uniform pricing for all their locations.

The core of our supply chain is a pair of world class integrated distribution centers, one in Central Germany and one in North America, from where we ship daily to our members.

To find your local supplier and for all other enquiries,
please contact **info@chrom4.com**

Please direct global company inquiries to **global@chrom4.com**

Distributor opportunities available.

Please contact **global@chrom4.com**



Hauptstrasse 365
Suhl-Wichtshausen
Thüringen, Germany
D-98530



Science Complex
60 Decibel Rd.
State College
Pennsylvania, USA
16801

Mentioned trademarks are registered trademarks of their respective owners. No license or immunity under any patent is granted or implied by our sale of any material. Chrom4 is not affiliated with any of the following companies listed, or their products. Products listed under the following companies are compatible with their instrumentation. Agilent™, Beckman, Bruker, CTC/Leap, Finneran, KingFisher™, PerkinElmer, Phenomenex®, Qiagen, SCION Instruments, Shimadzu, Thermo Scientific (Chromacol, La-Pha-Pack, National Scientific), Varian and Waters Corporation. Chrom4 is not an authorized seller of Agilent™ branded parts and does not sell genuine Agilent™ parts. Chrom4 only offers quality parts compatible with Agilent™ products.

TABLE OF CONTENTS



SAMPLE HANDLING PRODUCT OVERVIEW

SECTION

A

VIAL MANUFACTURING	A2	MICRO INSERTS & INSERT VIALS	A6
VARIOUS VIAL TYPES	A3	VIAL PACKAGING & ORDERING ..	A7
CAP SELECTION GUIDE	A4	AUTOSAMPLER CROSS REF	A7
SEPTA SELECTION GUIDE	A5		



ND

9

2ML SCREW TOP VIALS (11.6mm x 31.9mm)

2ML SCREW TOP VIALS	B1	9-425 BONDED CAPS	B7
INSERTS	B3	9-425 PRESS FIT CAPS	B9
INSERT VIALS	B4	VIAL & CAP KITS	B11
SEPTA GUIDE	B6	INSERT VIAL KITS	B13

SECTION

B



ND

11

2ML CRIMP TOP VIALS (11.6mm x 31.9mm)

2ML CRIMP TOP VIALS	C1	RECOVERY VIALS	C4
INSERTS	C3	11MM CRIMP CAPS	C5
INSERT VIALS	C4	CRIMP VIAL & CAP KITS	C6

SECTION

C



ND

11

2ML SNAP TOP VIALS (11.6mm x 31.9mm)

2ML SNAP CAP VIALS	D1	RECOVERY VIALS	D4
INSERTS	D3	11MM SNAP CAPS	D5
INSERT VIALS	D4		

SECTION

D



ND

8

2ML SCREW TOP VIALS (11.6mm x 31.9mm)

2ML SCREW TOP VIALS	E2	OPEN CAP & SEPTA	E2
INSERTS	E1	CLOSED CAPS	E2
8-425 SCREW TOP VIALS	E2	VIAL & CAP KITS	E2

SECTION

E



ND

10

2ML SCREW TOP VIALS (11.6mm x 31.9mm)

2ML SCREW TOP VIALS	F2	10-425 SCREW TOP CAPS	F2
INSERTS	F1	VIAL & CAP KITS	F2

SECTION

F



ND

13

4ML SCREW TOP VIALS

4ML SCREW TOP VIALS	G2	VIAL & CAP KITS	G2
13-425 SCREW TOP CAPS	G2	1ML SHELL VIALS	G2

SECTION

G



ND

8

CRIMP MICRO VIALS

8MM CRIMP TOP MICRO VIALS ..	H2	8MM CRIMP CAPS	H2
------------------------------	----	----------------------	----

SECTION

H



ND

18

SCREW TOP HEADSPACE VIALS

10ML SCREW TOP HS VIALS	I2	18-425 SCREW TOP CAPS	I3
20ML SCREW TOP HS VIALS	I2	VIAL & CAP KITS	I4

SECTION

I



ND

20

CRIMP TOP HEADSPACE VIALS

6ML CRIMP TOP HS VIALS.....	J2	20MM CRIMP CAPS	J3
10ML CRIMP TOP HS VIALS.....	J2	VIAL & CAP KITS	J4
20ML CRIMP TOP HS VIALS.....	J2		

SECTION

J

**CRIMPERS / DECAPPERS & SH TOOLS**

SAMPLE HANDLING TOOLS	K1	DECAPPERS	K2
CRIMPERS.....	K2		

SECTION

K

**STORAGE VIALS / DRAM VIALS**

4ML STORAGE VIALS	L2	15ML STORAGE VIALS	L3
7ML STORAGE VIALS	L2	STORAGE VIAL & CAP KITS	L4
10ML STORAGE VIALS	L3		

SECTION

L

**EPA VIALS & CAPS**

EPA VIALS AND CAPS.....	M1
-------------------------	----

SECTION

M

**96 WELL PLATES, INSERTS, MATS & SEALS**

96 WELL PLATES	N2	384 WELL PLATES	N12
48 & 24 DEEP WELL PLATES.....	N5	RESERVOIR TRAYS	N13
96 MEDIUM WELL PLATES.....	N6	INSERT VIALS	N13
96 SHALLOW WELL PLATES	N8	CAP MATS	N14
SEED GENOMIC PLATES	N10	SEAL DECISION TREE	N18
96 W MAGNETIC PLATES	N11	SBS PLATE SEALS.....	N22

SECTION

N

**VIAL SELECTION GUIDE**

VIAL SELECTION GUIDE	O1-O4
----------------------------	-------

SECTION

O

**FUTURE CATALOGUE**

SECTION

P



SAMPLE HANDLING ESSENTIALS



OUR VIALS

Our vials are produced under the most stringent conditions with highly sophisticated production technology out of 1st hydrolytic class glass. Ambeg and Spami vial forming machines guarantee to provide state-of-the-art solutions to manufacture world-class products. Our machines are equipped with opto-electronic devices, measuring within fractions of a second, whether the vial meets our specifications. A second photo camera checks for cosmetic errors (cracks, chips) in the glass. Length-gauging equipment measure dimensional specification in addition to the camera inspection.

All vials are packed in a clean room, therefore avoiding any chance of contamination.

A manual random inspection and final inspection to ISO and other quality standards will assure you of a great, problem-free and reliable product.

For our 2mL vials, only Schott glass is used as raw material, which results in an outstanding and problem-free product.



VIALS FOR SAMPLE HANDLING

At Chrom4 we offer one of the largest varieties of vials for all your sample handling needs including:



2mL Autosampler Vials



Micro Inserts



Microvials



Storage Vials



Headspace Vials

CHROM4 CERTIFIED & MS-CERTIFIED VIALS

Chrom4 chromatography vials are certified to conform or exceed Industry Standards producing a product that is clean, pure, with high hydrolytic stability. These vials are suitable for use with all GC/HPLC applications.

MS certified vials undergo a higher level of certification for minimal detectable background signal in MS, this makes MS certified vials ideal for all MS-based applications.

All lots of this product have been manufactured under a Quality Management System registered to ISO 9001. All glass vials are manufactured in a clean-room environment, using Schott FIOLAX® borosilicate glass tubing.

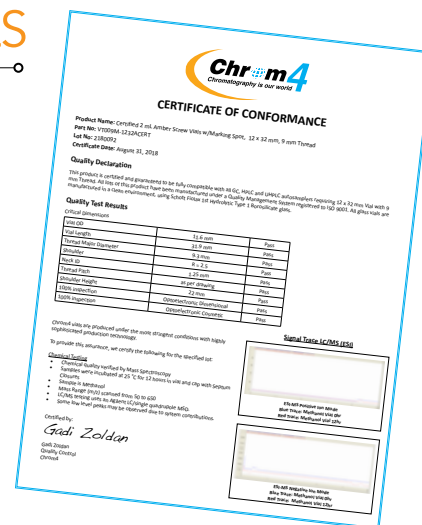

VIAL TOP SELECTIONS

We carry a large variety of autosampler vials ranging from screw top 2mL autosampler vials to 20mL headspace and storage vials.

Images below will guide you to select the correct vial for your autosampler and/or application.

On page A7 you will find our Autosampler Cross Reference to help select the right vial for your needs.

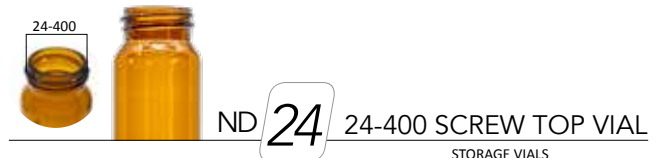
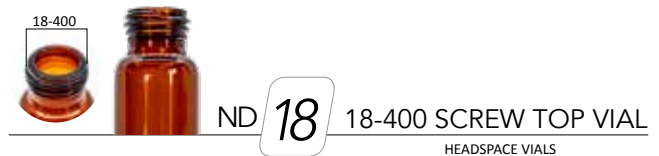
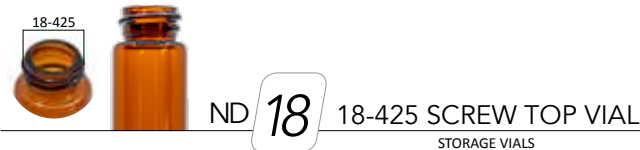
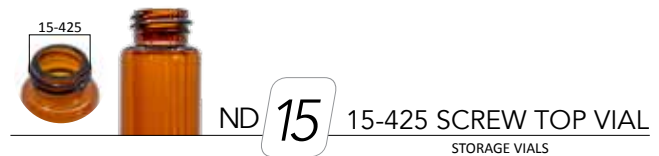
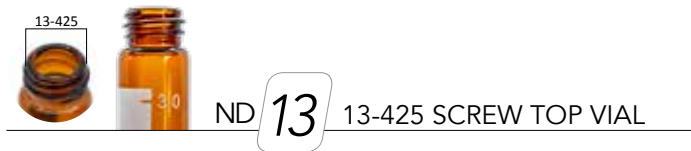
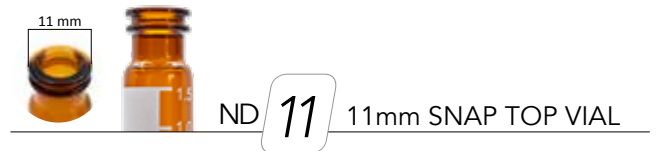
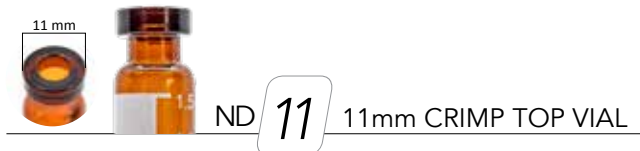
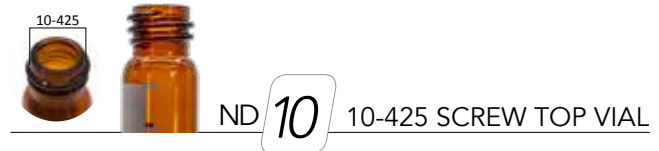
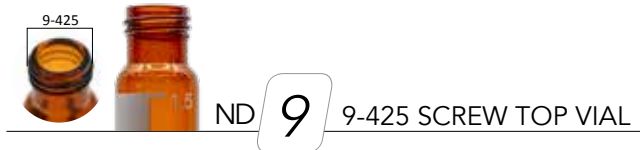
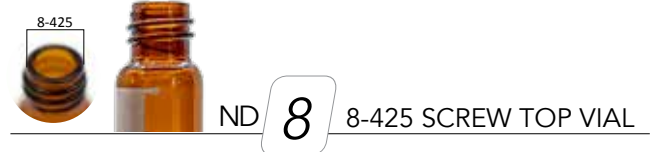
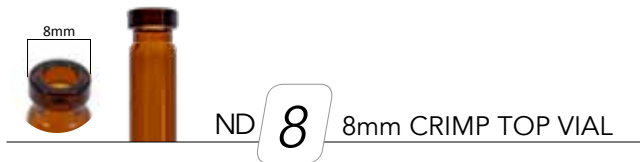

OUR CAPS

We offer a complete range of chromatography caps and septas, enabling you to choose what is right for your applications.

All septas are made from high quality rubber or silicone calendered with FEP or PTFE films under strict quality control processes in ISO 9001-2000 certified manufacturing facilities.

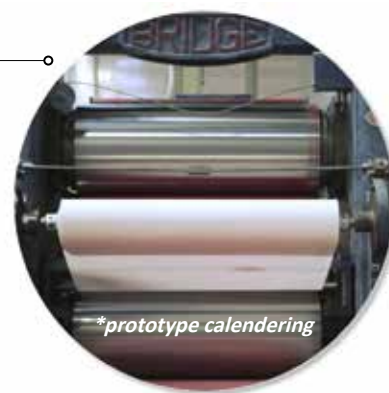

CAP SELECTIONS

For your convenience, the diagrams below help distinguish the various cap options available.



Screw Thread Cap



Short Thread Screw Cap



Snap Cap



Screw Thread Closed Cap



Crimp Cap



Pressure Release Crimp Caps



Magnetic Crimp Cap



Magnetic Screw Thread Cap



Polyethylene Cap for Wash Bottle



Pharma-Fix Crimp Cap

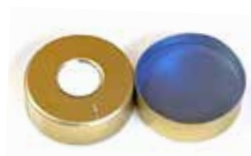

Magnetic SPME Cap

BONDED & PRESS FIT CAPS

ND9 short thread screw top caps are available with Bonded or Press-Fit septa options:

- Press-Fit caps have the septa pressed into the cap offering a sealed closure when the cap is tightened on the vial (Ex. Agilent™ instrumentation).
- For instruments where the sample needle tip is rounded, a Bonded septa cap can offer additional stability as the septa is sonically welded to the cap (Ex. Waters instrumentation).



Press-Fit Septa
Cap



Bonded Septa
Cap



SEPTA SELECTION

Various applications require a specific septa for optimum performance. Chrom4 offers a wide selection of septa's ranging from pierceability, resealability, temperature and chemical resilience. The following chart will help you select the right septa for your application.



FEP / Red Rubber Silicone

Application: Multiple Sampling
Highest resealable properties
-40°C - 110°C



PTFE (Red & Blue) / Silicone

Application: General Purpose
Thin / Fragile Needle
-40°C - 120°C



PTFE (Tan / Natural) / Silicone

Application: MS / Trace Analysis
Ultra Low Bleed
-40°C - 120°C



PTFE / SILICONE / PTFE

Laminated Septa
Minimal Coring
-40°C - 120°C



Clear Silicone

Application: MS/MS Analysis
MS Certified Septa
-40°C - 120°C



PTFE / Silicone / With Slit

Application: U(H)PLC
Preslit / Precut Septa
-40°C - 120°C



PVDC: PTFE Free

Application: PFOA / PFOS
Analysis
PTFE Free Septa
-40°C - 120°C



Foil

Application: Phthalates,
Elastomers, Plastomers
& PFOA / PFOS Analysis

INSERTS, INSERT VIALS & SPECIALITY VIALS

For low sampling volume or unique applications, Chrom4 carries a wide selection of Micro Inserts, Fused Insert Vials & Specialty Vials. For specific application support, please contact your Chrom4 Sales representative today!



Micro Inserts



Fused Insert Vials



Specialty Vials

VIAL PACKAGING OPTIONS:

Our Vials and Caps can be ordered in a variety of ways. All Vials, Caps & Inserts are available in packages of 100. For ease-of use in your laboratory, Chrom4 has assembled 'Convenience Kits' which offer both Vials and Caps in a single package with a single P/N for convenient ordering. Look for the 'Vial and Cap Kits' throughout the catalogue.

Chrom4 also offers a limited range of products as 'Pre-Assembled Kits' where the vials are pre-capped in a clean room environment.

PACKAGING OPTIONS:

100 Vial Package



Vial and Cap 'Convenience Kit'









Pre-Assembled Vial & Cap Kit



AUTOSAMPLER CROSS REFERENCE



AGILENT™

	Agilent™ Robotic Arm 1200 Series, 1100 Series, 1090 Series	
	2mL Screw Cap Vials (ND9).....	B2
	Screw Caps	B9
	Inserts.....	B3
	2mL Crimp Cap Vials (ND11).....	C2
	Crimp Caps.....	C5
	Inserts.....	C4
	2mL Snap Cap Vials (ND11).....	D1
	Snap Caps.....	D5
	Snap Cap Inserts.....	D3
	8mm Crimp Cap Microvials (ND8).....	H2
	8mm Crimp Caps	H2
	20mm Crimp Cap Headspace Vials (ND20).....	J2
	20mm Crimp Caps	J3





BECKMAN

	2mL Screw Cap Vials (ND8).....	E2
	Screw Caps	E2
	Inserts	E2



CTC/LEAP (Gerstel)

	CTC/LEAP 20mm Crimp Cap Headspace Vials (ND20)	J2
	20mm Crimp Caps (Including SPME)	J3
	CTC/LEAP 18mm Screw Thread Headspace Vials (ND18).....	I2
	Magnetic Screw Thread Caps	I3
	2mL Screw Cap Vials (ND9).....	B2
	Screw Caps	B9
	Inserts.....	B3





PERKIN ELMER

	2mL Screw Cap Vials (ND9).....	B2
	Screw Caps	B9
	Inserts.....	B3
	2mL Snap Cap Vials (ND11 Snap)	D2
	11mm Snap Caps	D5
	8mm Crimp Micro Vials (ND8)	H2
	8mm Crimp Caps	H2
	20mm Crimp Cap Headspace Vials (ND20) 6mL, 10mL & 20mL.....	J2
	20mm Crimp Caps	J3



SCION (Formerly Bruker, Varian)

	2mL Screw Cap Vials (ND9).....	B2
	Screw Caps	B7
	Inserts.....	B3
	2mL Large Opening Screw Thread Vials (ND10) <i>Previous Varian Models</i>	F2
	Caps	F2
	Inserts.....	F1

SHIMADZU

	2mL Screw Cap Vials (ND9) <i>Nexera Models</i>	B2
	Screw Caps	B7
	Inserts.....	B3
	2mL Crimp Cap Vials (ND11)	C2
	Crimp Caps.....	C5
	2mL Screw Cap Vials (ND8).....	E2
	Screw Caps	E2
	4mL Screw Thread Vials (ND13).....	G2
	4mL Screw Thread Caps.....	G2

THERMO SCIENTIFIC (Dionex)

	2mL Screw Cap Vials (ND9) <i>Ultimate 3000 Models</i>	B2
	Screw Caps	B9
	20mm Crimp Cap Headspace Vials (ND20).....	J2
	20mm Crimp Caps	J3

WATERS

	2mL Screw Cap Vials (ND9).....	B2
	Screw Caps (Bonded)	B7
	Inserts.....	B3
	Waters Wisp 48 and 96 position models	
	4mL Screw Cap Vials (ND13).....	G2
	4mL Screw Thread Caps (ND13).....	G2
	Shell Vials	G2

Mentioned trademarks are registered trademarks of their respective owners. No license or immunity under any patent is granted or implied by our sale of any material. Chrom4 is not affiliated with any of the following companies listed, or their products. Products listed under the following companies are compatible with their instrumentation. Agilent™, Beckman, Bruker, CTC/Leap, Finneran, KingFisher™, PerkinElmer, Phenomenex®, Qiagen, SCION Instruments, Shimadzu, Thermo Scientific (Chromacol, La-Pha-Pack, National Scientific), Varian and Waters Corporation. Chrom4 is not an authorized seller of Agilent™ branded parts and does not sell genuine Agilent™ parts. Chrom4 only offers quality parts compatible with Agilent™ products.

ND 9 2ML SCREW TOP VIALS (11.6 x 31.9mm)

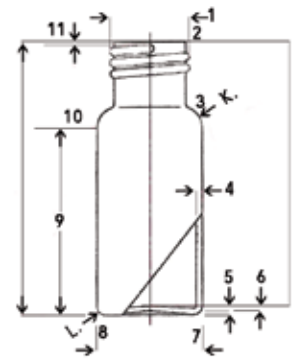
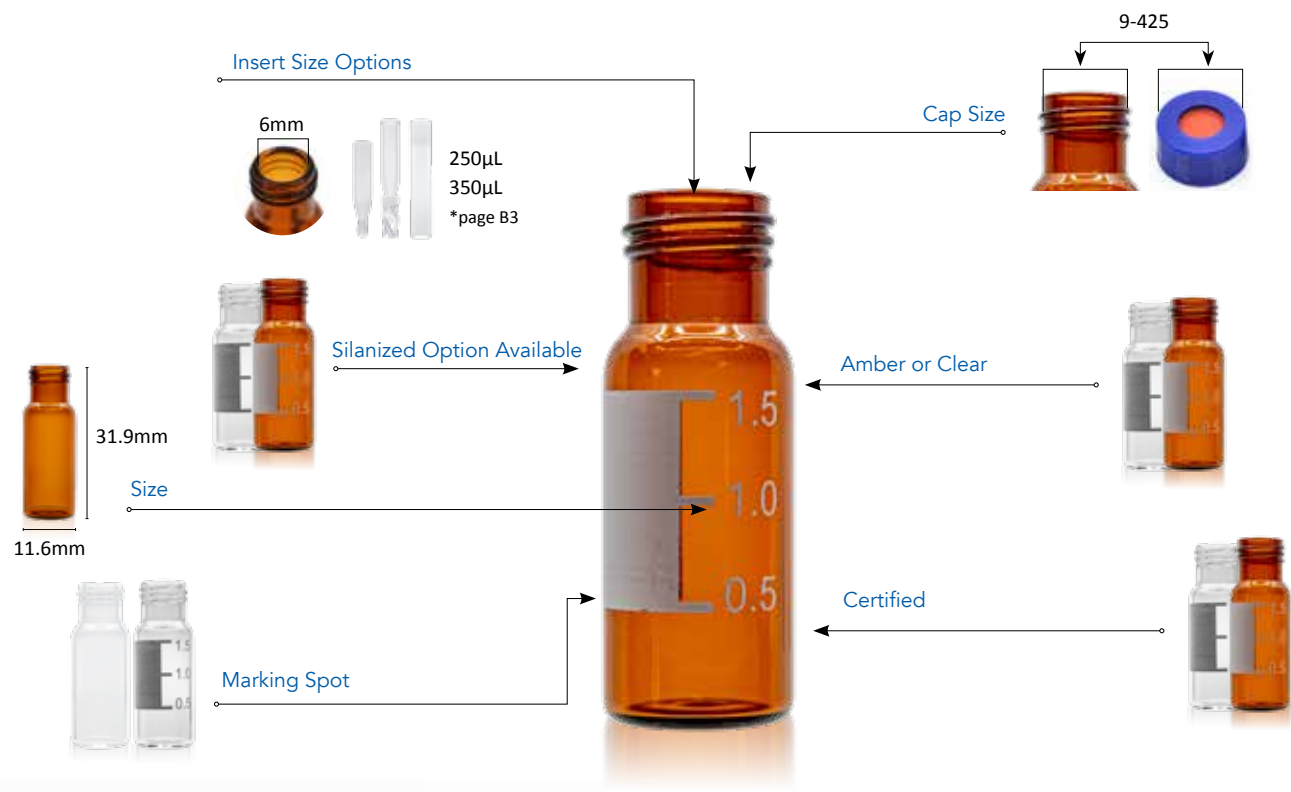



2ML SCREW TOP VIALS

P/N: /100	VT009-1232	VT009A-1232	VT009M-1232	VT009M-1232A	V0159P-1232
Material	Glass	Glass	Glass	Glass	Polypropylene
Clear	•		•		•
Amber		•		•	
Marking Spot			•	•	

2ML CERTIFIED & SILIANIZED VIALS

P/N: /100	VT009-1232S	VT009M-1232S	VT009M-1232AS	VT009-1232CERT	VT009M-1232CERT	VT009M-1232ACERT
Material	Glass	Glass	Glass	Glass	Glass	Glass
Clear	•	•		•	•	
Amber			•			•
Marking Spot		•	•		•	•
Silianized	•	•	•			
Certified				•	•	•

ND 9 2ML SCREW TOP INSERT VIALS & MICRO INSERTS

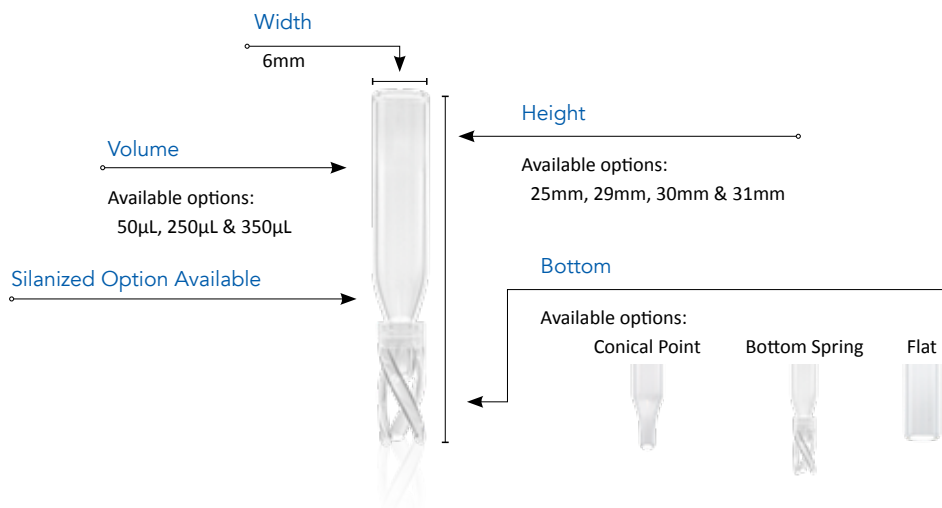

MICRO INSERTS

P/N: /100	1025-629	1025BS-629	1025-630	1025CP-631	1025GF-631	1025PBS-629	1025PFT-629	1025P-631
Material	Glass	Glass	Glass	Glass	Glass	Polypropylene	Polypropylene	Polypropylene
Volume	250µL	250µL	350µL	250µL	250µL	250µL	250µL	250µL
Bottom	Conical	Conical Bottom Spring	Flat	Conical	Conical Hanging	Conical Bottom Spring	Integrated Spring	Conical
Silanzed		1025BS-629S						





300µL FUSED INSERT VIALS

P/N: /100	VB309-1232	VB309-1232A	VB309M-1232	VB309M-1232A	VG309-1232	V0309P-1232
Material	Glass	Glass	Glass	Glass	Glass	Polypropylene
Volume	300µL	300µL	300µL	300µL	300µL	300µL
Clear	•		•		•	•
Amber		•		•		
Marking Spot			•	•		

RECOVERY VIALS

P/N: /100	V01509-1232	V01509-1232A	CHR05100SC	CHR05100ASC	CHR095SC	CHR095ASC	CHR099SC
Material	Glass	Glass	Glass	Glass	Glass	Glass	Glass
Residual Volume	15µL	15µL	25µL	25µL	25µL	25µL	4µL
Clear	•		•		•		•
Amber		•		•		•	

ND 9 2ML SCREW TOP CAPS

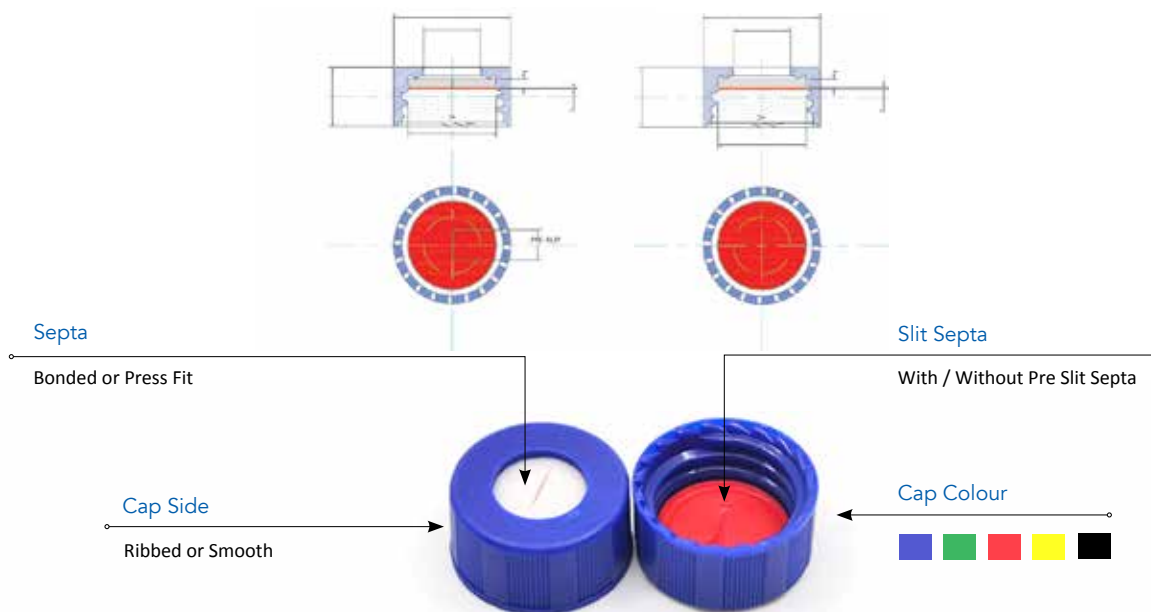

SEPTA SELECTION GUIDE

At Chrom4 we offer a wide selection of specialty septas to meet your analytical requirements. The following chart will help you select the right cap and septa for your application.

	Septa Type	Usage	Details
	FEP / Red Rubber Silicone	Multiple Sampling	Highest resealable properties
	PTFE (Red & Blue) / Silicone	General Purpose	Thin / Fragile Needle
	PTFE (Tan / Natural) / Silicone	MS / Trace Analysis	Ultra Low Bleed Septa
	PTFE / SILICONE / PTFE	Laminated Septa	Minimal Coring
	Clear Silicone	MS/MS Analysis	MS Certified Septa
	PVDC: PTFE Free	PFOA / PFOS Analysis	PTFE Free Septa
	PTFE / Silicone / With Slit	U(H)PLC	Preslit / Precut Septa
	Aluminium Foil	Phthalates, Elastomers & Plastomers PFOA / PFOS Analysis	Special Application
	CLOSED CAP	PLEASE REFER TO SECTION L FOR ALL STORAGE VIALS AND CAPS	



ND9 2ML SCREW TOP CAPS



Phthalates, Elastomers & Plastomers

ND 9 2ML SCREW TOP BONDED CAPS (for Waters Instruments)

PTFE / RED RUBBER SILICONE



P/N: /100	C394-09B	C394-09G	C394-09R
Septa	PTFE/Red Rubber Silicone	PTFE/Red Rubber Silicone	PTFE/Red Rubber Silicone
Durometer	60A	60A	60A
Thickness	0.040" (1mm)	0.040" (1mm)	0.040" (1mm)
Cap Side	Ribbed	Ribbed	Ribbed
Slit			
Colour	Blue	Green	Red
Bonded	•	•	•

ULB TAN PTFE / SILICONE



P/N: /100	C395-094B
Septa	ULB Tan PTFE/Silicone
Durometer	45A
Thickness	0.040" (1mm)
Cap Side	Ribbed
Slit	
Colour	Blue
Bonded	•

RED PTFE / SILICONE



P/N: /100	C395-09B	C395-09G	C395-09R	C395-09Y	C395-09BL
Septa	Red PTFE/Silicone	Red PTFE/Silicone	Red PTFE/Silicone	Red PTFE/Silicone	Red PTFE/Silicone
Durometer	38-45A	38-45A	38-45A	38-45A	38-45A
Thickness	0.040" (1mm)	0.040" (1mm)	0.040" (1mm)	0.040" (1mm)	0.040" (1mm)
Cap Side	Ribbed	Ribbed	Ribbed	Ribbed	Ribbed
Slit					
Colour	Blue	Green	Red	Yellow	Black
Bonded	•	•	•	•	•

NATURAL PTFE / SILICONE



P/N: /100	C395-09LC
Septa	Natural PTFE/Silicone
Durometer	50A
Thickness	0.040" (1mm)
Cap Side	Ribbed
Slit	
Colour	Blue
Bonded	•



TAN PTFE / SILICONE

P/N: /100	C395S-09B	C395S-09G	C395S-09R
Septa	Tan PTFE/Silicone	Tan PTFE/Silicone	Tan PTFE/Silicone
Durometer	50A	50A	50A
Thickness	0.040" (1mm)	0.040" (1mm)	0.040" (1mm)
Cap Side	Ribbed	Ribbed	Ribbed
Slit			
Colour	Blue	Green	Red
Bonded	•	•	•

NATURAL PTFE / SILICONE W/ SLIT

P/N: /100	C397-09LC
Septa	Natural PTFE/Silicone
Durometer	50A
Thickness	0.040" (1mm)
Cap Side	Ribbed
Slit	•
Colour	Blue
Bonded	•

RED PTFE / SILICONE W/ SLIT

P/N: /100	C397-09B	C397-09G	C397-09R	C397-09Y	C397-09BL
Septa	Red PTFE/Silicone	Red PTFE/Silicone	Red PTFE/Silicone	Red PTFE/Silicone	Red PTFE/Silicone
Durometer	38-45A	38-45A	38-45A	38-45A	38-45A
Thickness	0.040" (1mm)	0.040" (1mm)	0.040" (1mm)	0.040" (1mm)	0.040" (1mm)
Cap Side	Ribbed	Ribbed	Ribbed	Ribbed	Ribbed
Slit	•	•	•	•	•
Colour	Blue	Green	Red	Yellow	Black
Bonded	•	•	•	•	•

ULB TAN PTFE / SILICONE W/ SLIT

P/N: /100	C397S-09B	C397S-09G
Septa	ULB Tan PTFE/Silicone	ULB Tan PTFE/Silicone
Durometer	50A	50A
Thickness	0.040" (1mm)	0.040" (1mm)
Cap Side	Ribbed	Ribbed
Slit	•	•
Colour	Blue	Green
Bonded	•	•

PTFE / ORANGE SILICONE

P/N: /100	C39D-09B	C39G-09B
Septa	PTFE/Orange Silicone	PTFE/Orange Silicone
Durometer	45A	45A
Thickness	0.040" (1mm)	0.040" (1mm)
Cap Side	Ribbed	Ribbed
Slit		•
Colour	Blue	Green
Bonded	•	•

CLEAR SILICONE







P/N: /100	C399-09B
Septa	Clear LC Clean
Durometer	45A
Thickness	0.040" (1mm)
Cap Side	Ribbed
Slit	
Colour	Blue
Bonded	•

ND 9 2ML SCREW PRESS-FIT CAPS

ULB RED PTFE / SILICONE WITH OR WITHOUT SLIT - VALUE CAPS (Sold per 1,000 only)

						
P/N: /1,000	C39E-09B (per 1,000 caps)	C39E-09R (per 1,000 caps)	C39E-09BL (per 1,000 caps)	C39RG-09B (per 1,000 caps)	C39RG-09R (per 1,000 caps)	C39RG-09BL (per 1,000 caps)
Septa	ULB Red PTFE/Silicone	ULB Red PTFE/Silicone	ULB Red PTFE/Silicone	ULB Red PTFE/Silicone	ULB Red PTFE/Silicone	ULB Red PTFE/Silicone
Durometer	50A	50A	50A	50A	50A	50A
Thickness	0.040" (1mm)	0.040" (1mm)	0.040" (1mm)	0.040" (1mm)	0.040" (1mm)	0.040" (1mm)
Cap Side	Ribbed	Ribbed	Ribbed	Ribbed	Ribbed	Ribbed
Slit				•	•	•
Colour	Blue	Red	Black	Blue	Red	Black

TAN PTFE / RED RUBBER SILICONE FEP / RED RUBBER SILICONE

						
P/N: /100	C394-09SB	C394-09SG	C394-09SR	C394-09SGR	C394E-09B	C395S-09DB
Septa	Tan PTFE/Red Rubber Silicone	Tan PTFE/Red Rubber Silicone	FEP/Red Rubber Silicone	FEP/Red Rubber Silicone	FEP/Red Rubber Silicone	FEP/Red Rubber Silicone
Durometer	50A	50A	50A	50A	50A	50A
Thickness	0.040" (1mm)	0.040" (1mm)	0.040" (1mm)	0.040" (1mm)	0.040" (1mm)	0.040" (1mm)
Cap Side	Ribbed	Ribbed	Smooth	Smooth	Ribbed	Ribbed
Slit						
Colour	Blue	Green	Red	Green	Blue	Dark Blue

PTFE / SILICONE

					
P/N: /100	C395-09SB	C395-09SG	C395-09SR	C395-09SY	C395-09SBL
Septa	PTFE/Silicone	PTFE/Silicone	Red PTFE/Silicone	PTFE/Silicone	PTFE/Silicone
Durometer	50A	50A	50A	50A	50A
Thickness	0.040" (1mm)	0.040" (1mm)	0.040" (1mm)	0.040" (1mm)	0.040" (1mm)
Cap Side	Smooth	Smooth	Smooth	Smooth	Smooth
Slit					
Colour	Blue	Green	Red	Yellow	Black



PTFE / SILICONE

P/N: /100	C395E-09B	C395E-09SB	C395E-09SG	C395E-09SR	C395E-09SY
Septa	PTFE/Silicone	PTFE/Silicone	PTFE/Silicone	PTFE/Silicone	PTFE/Silicone
Durometer	50A	50A	50A	50A	50A
Thickness	0.040" (1mm)	0.040" (1mm)	0.040" (1mm)	0.040" (1mm)	0.040" (1mm)
Cap Side	Ribbed	Smooth	Smooth	Smooth	Smooth
Slit					
Colour	Blue	Blue	Green	Red	Yellow



BLUE PTFE / SILICONE

P/N: /100	C395EB-09SBL
Septa	Blue PTFE/Silicone
Durometer	50A
Thickness	0.040" (1mm)
Cap Side	Smooth
Slit	
Colour	Black

PTFE / SILICONE / PTFE

P/N: /100	C396E-09SG
Septa	PTFE/Silicone/PTFE
Durometer	50A
Thickness	0.040" (1mm)
Cap Side	Smooth
Slit	
Colour	Green

CLEAR PVDC: PTFE FREE

P/N: /100	C389-09B	C389S-09B
Septa	PVDC, PTFE Free	PVDC, PTFE Free
Durometer	43A	43A
Thickness	0.040" (1mm)	0.040" (1mm)
Cap Side	Ribbed	Ribbed
Slit		•
Colour	Blue	Blue

Note: For analytes where PTFE interferes with the sample, such as PFOS, PFOA, etc.

PTFE / SILICONE / PTFE

P/N: /100	C396-09RIB	C396-09RIBG	C396-09RIBR	C396-09RIBY	C396-09SB	C396-09SG	C396-09SR	C396-09SY
Septa	PTFE/Silicone/PTFE	PTFE/Silicone/PTFE	PTFE/Silicone/PTFE	PTFE/Silicone/PTFE	PTFE/Silicone/PTFE	PTFE/Silicone/PTFE	PTFE/Silicone/PTFE	PTFE/Silicone/PTFE
Durometer	50A	50A	50A	50A	50A	50A	50A	50A
Thickness	0.040" (1mm)	0.040" (1mm)	0.040" (1mm)	0.040" (1mm)	0.040" (1mm)	0.040" (1mm)	0.040" (1mm)	0.040" (1mm)
Cap Side	Ribbed	Ribbed	Ribbed	Ribbed	Smooth	Smooth	Smooth	Smooth
Slit								
Colour	Blue	Green	Red	Yellow	Blue	Green	Red	Yellow

PTFE / SILICONE W/ SLIT

P/N: /100	C397E-09B	C397E-09SB
Septa	PTFE/ Silicone	PTFE/Silicone
Durometer	50A	50A
Thickness	0.040" (1mm)	0.040" (1mm)
Cap Side	Ribbed	Smooth
Slit	•	•
Colour	Blue	Blue

FEP / RED RUBBER W/SLIT

P/N: /100	C394S-09SGR
Septa	FEP/Red Rubber Silicone
Durometer	50A
Thickness	0.040" (1mm)
Cap Side	Smooth
Slit	•
Colour	Green

ALUMINIUM FOIL CAP

P/N: /100	C393-09B
Septa	Aluminium Foil
Durometer	N/A
Thickness	N/A
Cap Side	Ribbed
Slit	
Colour	Blue

ND 9 2ML SCREW TOP VIAL & CAP KITS



PRE-CAPPED VIALS

Cap P/N:	Septa	Bonded	Slit	Cap Side	VT009M-1232	VT009M-1232A
C394-09B	PTFE/Red Rubber Silicone	•		Ribbed		853949A-1232
C394-09G	PTFE/Red Rubber Silicone	•		Ribbed		853949GA-1232
C394-09SG	Tan PTFE/Red Rubber Silicone			Ribbed	853949SG-1232	853949SGA-1232
C394-09SGR	FEP/Red Rubber Silicone			Smooth	853949SGR-1232	853949SGRA-1232
C394E-09B	PTFE/Red Rubber Silicone			Ribbed	853949EB-1232M	
C394S-09SGR	FEP/Red Rubber Silicone		•	Smooth	853949SSGR-1232	853949SSGR-1232A
C395-09B	Red PTFE/Silicone	•		Ribbed	853959B-1232	853959BA-1232
C395-09G	Red PTFE/Silicone	•		Ribbed	853959G-1232	853959GA-1232
C395-09SB	Red PTFE/Silicone			Smooth	853959SB-1232	
C395E-09SB	Red PTFE/Silicone			Smooth	853959ESB-1232	853959ESBA-1232
C395E-09SG	Red PTFE/Silicone			Smooth	853959ESG-1232	853959ESG-1232A
C396E-09B	PTFE/Silicone/PTFE			Ribbed		853969EB-1232A
C396E-09SG	PTFE/Silicone/PTFE			Smooth		853969ESG-1232A
C397-09B	Red PTFE/Silicone	•	•	Ribbed	853979B-1232	853979B-1232A
C397-09SB	Red PTFE/Silicone		•	Smooth	853979SB-1232	853979SB-1232A
C397E-09SB	Red PTFE/Silicone		•	Smooth		853979ESB-1232A
C397S-09B	Tan PTFE/Silicone	•	•	Ribbed	85397S9B-1232	85397S9B-1232A

/100 pcs



2ML VIAL & CAP CONVENIENCE KITS











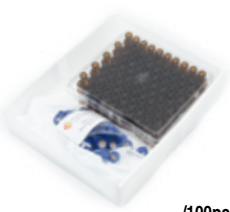

Cap P/N:	Septa	Bonded	Slit	Cap Side	VT009-1232	VT009M-1232	VT009M-1232A
C39RE-09B	Red PTFE/Silicone			Ribbed		VT009M/C39RE VT009M/C39RECERT	VT009MA/C39RE VT009MA/C39RECERT
C39RG-09B	Red PTFE/Silicone		•	Ribbed		VT009M/C39RG VT009M/C39RGCERT	VT009MA/C39RG VT009MA/C39RGCERT
C39S-09G	Red PTFE/Silicone	•		Ribbed			VT009MA/C39S-G
C39S-09SB	Red PTFE/Silicone			Smooth	VT009/C39S-SB		
C39S-09SBL	Red PTFE/Silicone			Smooth	VT009/C39S-SBL		
C39S-09SG	Red PTFE/Silicone			Smooth	VT009/C39S-SG		
C39S-09SR	Red PTFE/Silicone			Smooth	VT009/C39S-SR		
C39S-09SY	Red PTFE/Silicone			Smooth	VT009/C39S-SY		
C395E-09SB	Red PTFE/Silicone			Ribbed	VT009/C395-ESB	VT009MS/C395-ESB	
C395E-09SG	Red PTFE/Silicone			Smooth	VT009/C395-ESG		
C395S-09G	Tan PTFE/Silicone	•		Ribbed	VT009/C395S-09G		VT009MA/C395S-GCERT
C396-09SB	PTFE/Silicone /PTFE			Smooth	VT009/C396-SB		VT009MA/C396-SB
C397-09B	Red PTFE/Silicone	•	•	Ribbed	VT009/C397-B	VT009M/C397-BCERT VT009MS/C397-B	VT009MA/C397-BCERT
C397-09R	Red PTFE/Silicone	•	•	Ribbed		VT009M/C397-R	
C397E-09B	Red PTFE/Silicone		•	Ribbed		VT009M/C397-EB	
C397E-09SB	Red PTFE/Silicone		•	Smooth	VT009/C397-ESB		
C397S-09B	Tan PTFE/Silicone	•	•	Ribbed		VT009M/C397-SB VT009M/C397-SCERT	VT009MA/C397-SCERT

* RED = Certified Vial BLUE = Silanized Vial

/100 pcs

ND 9 2ML SCREW TOP INSERT VIAL KITS

INSERT VIAL & CAP KITS

							
	/100pcs	VB309-1232	VB309M-1232	VB309-1232A	VB309M-1232A	V0309P-1232	
BONDED CAP		C395-09SBL	VB309/C395-09SBL	VB309M/C395-09SBL	VB309A/C395-09SBL	VB309MA/C395-09SBL	V0309P/C395-09SBL
		C397S-09B	VB309/C397S-09B	VB309M/C397S-09B	VB309A/C397S-09B	VB309MA/C397S-09B	V0309P/C397S-09B
		C395S-09B	VB309/C395S-09B	VB309M/C395S-09B	VB309A/C395S-09B	VB309MA/C395S-09B	V0309P/C395S-09B
		C395-09B	VB309/C395-09B	VB309M/C395-09B	VB309A/C395-09B	VB309MA/C395-09B	V0309P/C395-09B
		C397-09B	VB309/C397-09B	VB309M/C397-09B	VB309A/C397-09B	VB309MA/C397-09B	V0309P/C397-09B
PRESS FIT CAP		C39RE-09B	VB309/C39RE09B	VB309M/C39RE09B	VB309A/C39RE09B	VB309MA/C39RE09B	V0309P/C39RE09B
		C39RG-09B	VB309/C39RG09B	VB309M/C39RG09B	VB309A/C39RG09B	VB309MA/C39RG09B	V0309P/C39RG09B

VIAL & SEPARATE INSERT KITS

			
/100pcs	VT009M-1232	VT009M-1232A	
	I025GF-631	VT009M/I025GF	VT009AM/I025GF
	I025BS-629	VT009M/I025BS	VT009AM/I025BS
	I025CP-631	VT009M/I025CP	VT009AM/I025CP
	I025-630	VT009M/I025-630	VT009AM/I025-630

RECOVERY VIAL & CAP KITS



	/100pcs	CHR05100SC	CHR05100ASC	CHR095SC	CHR095ASC	CHR099SC	
BONDED CAP		C395S-09B	CHR05100SC/C395S09B	CHR05100ASC/C395S09B	CHR095SC/C395S09B	CHR095ASC/C395S09B	CHR099SC/C395S09B
		C397S-09B	CHR05100SC/C397S09B	CHR05100ASC/C397S09B	CHR095SC/C397S09B	CHR095ASC/C397S09B	CHR099SC/C397S09B
PRESS FIT CAP		C396-09RIB	CHR05100SC/C396S0RIB	CHR05100ASC/C396S0RIB	CHR095SC/C396S0RIB	CHR095ASC/C396S0RIB	CHR099SC/C396S0RIB
		C39RE-09B	CHR05100SC/C39RE09B	CHR05100ASC/C39RE09B	CHR095SC/C39RE09B	CHR095ASC/C39RE09B	CHR099SC/C39RE09B
		C39RG-09B	CHR05100SC/C39RG09B	CHR05100ASC/C39RG09B	CHR095SC/C39RG09B	CHR095ASC/C39RG09B	CHR099SC/C39RG09B



ND 11 2ML CRIMP TOP VIALS (11.6 x 31.9mm)

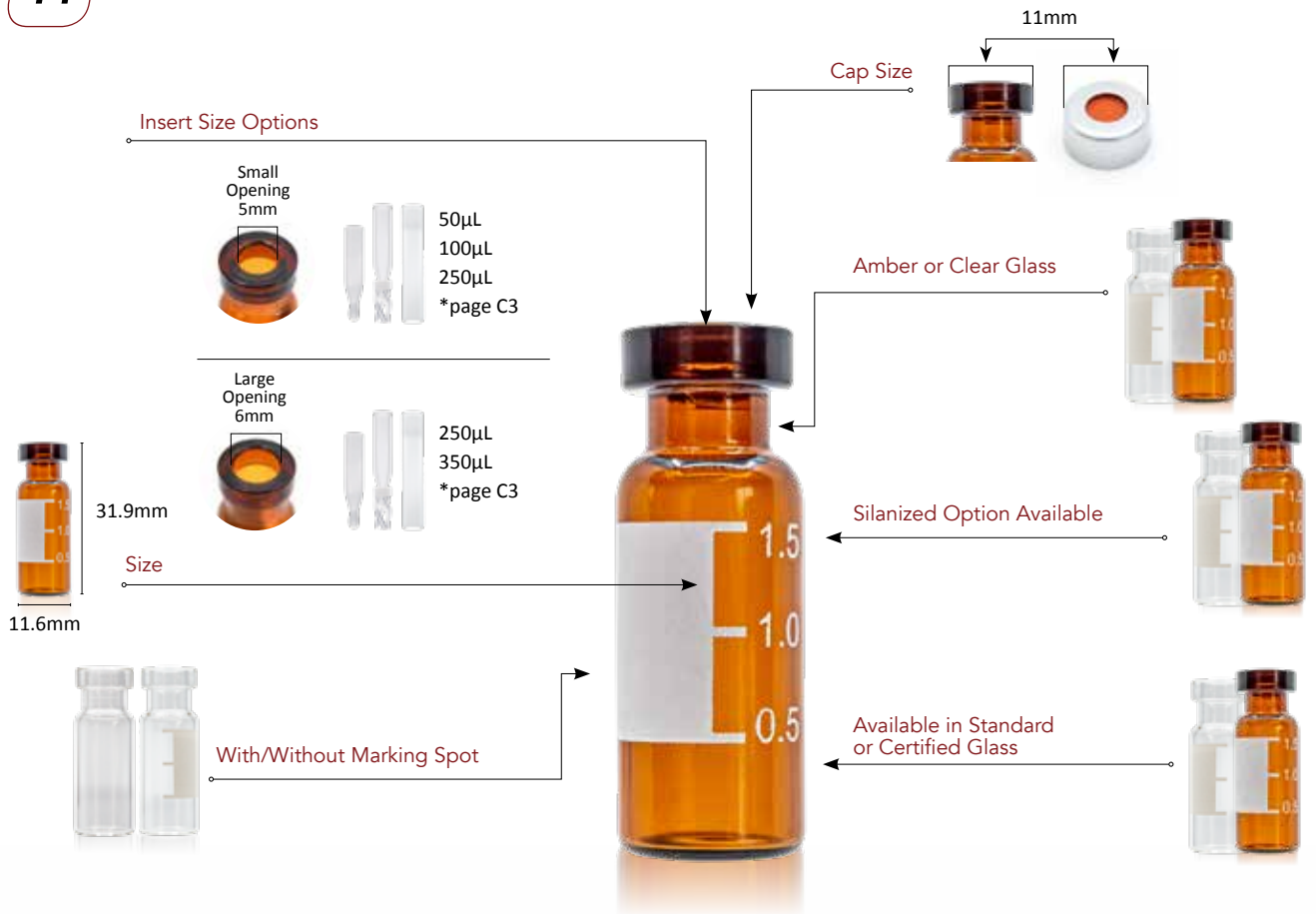

SMALL 5mm OPENING VIALS

LARGE 6mm OPENING VIALS

ND **11**





Small Opening 5mm





P/N: /100	VT011-1232	VT011M-1232A
Opening Size	5mm	5mm
Clear	•	
Amber		•
Marking Spot		•

Large Opening 6mm







P/N: /100	VT011L-1232	VT011LM-1232	VT11LM-1232A
Opening Size	6mm	6mm	6mm
Clear	•	•	
Amber			•
Marking Spot		•	•



ND11 2ML CRIMP TOP VIALS (11.6 x 31.9mm)

CERTIFIED & SILIANIZED LARGE OPENING VIALS

Large Opening 6mm









P/N: /100	VT011L-1232S	VT011LM-1232S	VT11LM-1232AS	VT011L-1232T	VT011LM-1232T	VT11LM-1232AT
Opening	6mm	6mm	6mm	6mm	6mm	6mm
Clear	•	•		•	•	
Amber			•			•
Marking Spot		•	•		•	•
Silianized	•	•	•			
Certified				•	•	•

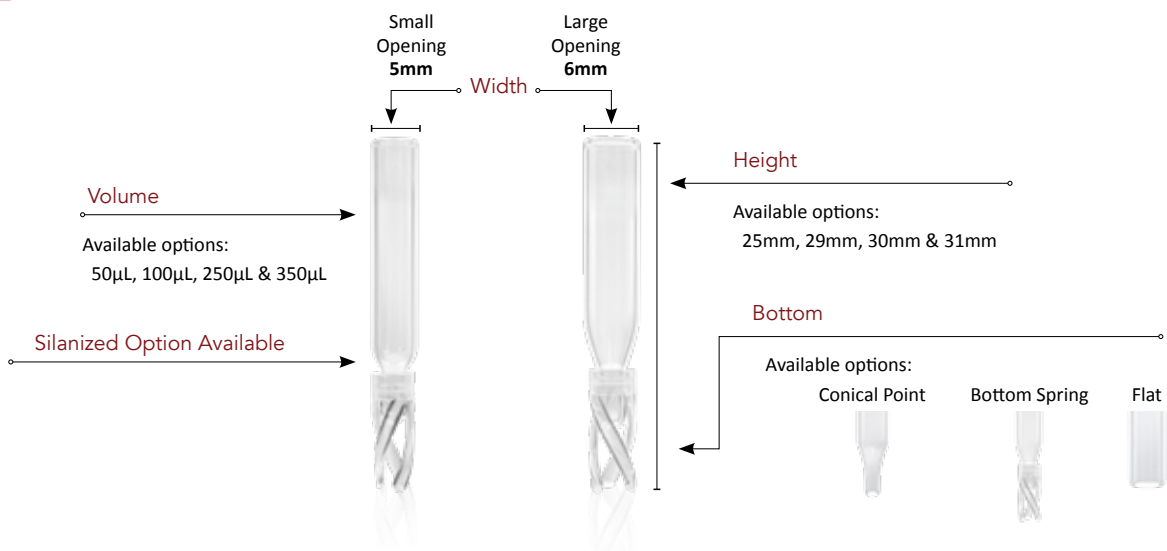





CRIMPERS & DECAPPERS AVAILABLE ON **PAGE K2**











ND 11 2ML CRIMP TOP MICRO INSERTS & INSERT VIALS



SMALL OPENING (5mm) MICRO INSERTS





						
P/N: /100		I005BS-625	I01-531	I01BS-530	I025-531	I01PBS-530
Material		Glass	Glass	Glass	Glass	Polypropylene
Volume		50µL	100µL	100µL	250µL	100µL
Bottom		Conical Bottom Spring	Conical	Bottom Spring	Flat Bottom	Conical Bottom Spring
Silanized				I01BS-530S		

LARGE OPENING (6mm) MICRO INSERTS

									
P/N: /100		I025-629	I025BS-629	I025-630	I025CP-631	I025GF-631	I025PBS-629	I025PFT-629	I025P-631
Material		Glass	Glass	Glass	Glass	Glass	Polypropylene	Polypropylene	Polypropylene
Volume		250µL	250µL	350µL	250µL	250µL	250µL	250µL	250µL
Bottom		Conical	Conical Bottom Spring	Flat	Conical	Conical Hanging	Conical Bottom Spring	Integrated Spring	Conical
Silanized			I025BS-629S						



300µL FUSED INSERT VIALS

				
P/N: /100	VB311C-1232	VB311MC-1232	VT311MC-1232A	VG311C-1232
Material	Glass	Glass	Glass	Glass
Volume	300µL	300µL	300µL	300µL
Clear	•	•		•
Amber			•	
Marking Spot		•	•	

RECOVERY VIALS

					
P/N: /100	V01511-1232	V01511-1232A	V1111-1232	CHR05100CR	VE062002
Material	Glass	Glass	Glass	Glass	Glass
Res Volume	15µL	15µL	15µL	25µL	4µL
Clear	•		•	•	•
Amber		•			

ND 11 2ML CRIMP CAPS

PTFE / RED RUBBER SILICONE

				
P/N: /100	C141-11B	C141-11G	C141-11GO	C141-11R
Septa	PTFE/Red Rubber Silicone	PTFE/Red Rubber Silicone	PTFE/Red Rubber Silicone	PTFE/Red Rubber Silicone
Durometer	50A	50A	50A	50A
Thickness	0.040" (1mm)	0.040" (1mm)	0.040" (1mm)	0.040" (1mm)
Colour	Blue	Green	Gold	Red

PTFE / RED RUBBER SILICONE

	
P/N: /100	C142-11
Septa	PTFE/Red Rubber Silicone
Durometer	50A
Thickness	0.040" (1mm)
Colour	Silver

PTFE / BUTYL RUBBER

	
P/N: /100	C144-11
Septa	PTFE/Butyl Rubber
Durometer	50A
Thickness	0.040" (1mm)
Colour	Silver

NATURAL PTFE / ORANGE SILICONE

	
P/N: /100	C149-11
Septa	Natural PTFE/Orange Silicone
Durometer	45A
Thickness	0.040" (1mm)
Colour	Silver

PTFE / SILICONE

	
P/N: /100	C150-11
Septa	PTFE/Silicone
Durometer	50A
Thickness	0.040" (1mm)
Colour	Silver





PTFE / SILICONE / PTFE



P/N: /100	C160S-11
Septa	PTFE/Silicone/PTFE
Durometer	
Thickness	
Colour	Silver
Slit	

PTFE / SILICONE - MAGNETIC



P/N: /100	C170-11
Septa	PTFE/Silicone
Durometer	
Thickness	
Colour	Gold
Magnetic	•

PTFE / SILICONE - W/ SLIT









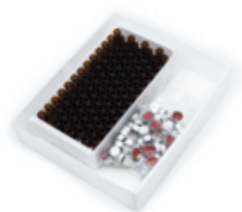

P/N: /100	C190-11
Septa	PTFE/Silicone
Durometer	
Thickness	
Colour	Silver
Slit	•

ALUMINIUM FOIL



P/N: /100	C193-11
Septa	Aluminium Foil
Durometer	N/A
Thickness	N/A
Colour	Silver
Slit	

ND11 CRIMP VIAL & CAP KITS

				
/100 pcs	VT011-1232	VT011L-1232	VT011LM-1232	VT11LM-1232A
 C142-11	VT011/C142	VT011L/C142	VT011LM/C142	VT11LMA/C142
 C144-11	VT011/C144	VT011L/C144	VT011LM/C144	VT11LMA/C144
 C190-11	VT011/C190	VT011L/C190	VT011LM/C190	VT11LMA/C190



ND 11 2ML SNAP TOP VIALS (11.6 x 31.9mm)

Insert Size Options

Large Opening
6mm



250µL
350µL
*page D3



31.9mm

11.6mm

Size



With/Without Marking Spot

Cap Size

11mm



Amber or Clear Glass



Silanzed Option Available



Available in Standard
or Certified Glass

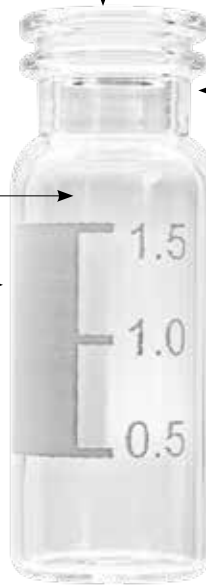



2ML SNAP TOP VIALS

<p>Large Opening 6mm</p>		
P/N: /100	VT011SM-1232	VT11SM-1232A
Opening	6mm	6mm
Clear	•	
Amber		•
Marking Spot	•	•

2ML SNAP TOP CERTIFIED & SILANIZED VIALS





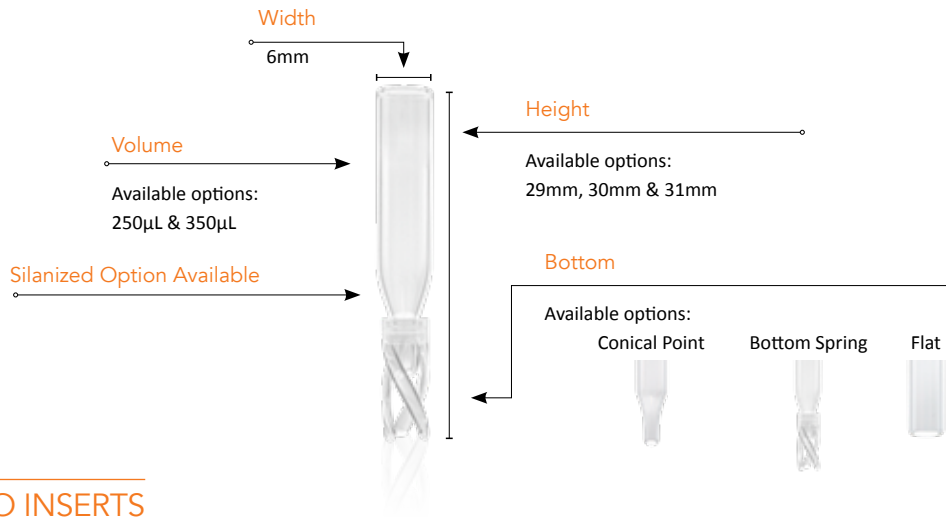



P/N: /100	VT011S-1232S	VT011SM-1232S	VT11SM-1232AS	VT011SM-1232T	VT11SM-1232AT
Opening	6mm	6mm	6mm	6mm	6mm
Clear	•	•		•	
Amber			•		•
Marking Spot		•	•	•	•
Silanized	•	•	•		
Certified				•	•

ND 11 2ML SNAP TOP MICRO INSERTS & INSERT VIALS



MICRO INSERTS



								
P/N: /100	I025-629	I025BS-629	I025-630	I025CP-631	I025GF-631	I025PBS-629	I025PFT-629	I025P-631
Material	Glass	Glass	Glass	Glass	Glass	Polypropylene	Polypropylene	Polypropylene
Volume	250µL	250µL	350µL	250µL	250µL	250µL	250µL	250µL
Bottom	Conical	Conical Bottom Spring	Flat	Conical	Conical Hanging	Conical Bottom Spring	Integrated Spring	Conical
Silanized		I025BS-629S						





300µL FUSED INSERT VIALS

P/N: /100	VB311-1232	VB311M-1232	VB311MA-1232	VG311-1232	V0300P-1232
Material	Glass	Glass	Glass	Glass	Polypropylene
Volume	300µL	300µL	300µL	300µL	300µL
Clear	•	•		•	•
Amber			•		
Fused	Bottom	Bottom	Bottom	Fused Bottom - Solid Top	
Marking Spot		•	•		

RECOVERY VIALS

P/N: /100	V01511S-1232	V01511S-1232A	V0700P-1232	V0711P-1232	CHR05100SN	VE062392
Material	Glass	Glass	Polypropylene	Polypropylene	Glass	Glass
Res Volume	15µL	15µL	700µL	750µL	25µL	4µL
Clear	•		•	•	•	•
Amber		•				

ND 11 2ML SNAP CAPS

PTFE / RED RUBBER SILICONE



P/N: /100	C240-11
Septa	PTFE/Red Rubber Silicone
Durometer	60A
Thickness	0.040" (1mm)
Colour	CLEAR
Slit	•

RED PTFE / SILICONE



P/N: /100	C250BS-11	C250-11	C250ST-11	C250ST-11S
Septa	Red PTFE/Silicone	Red PTFE/Silicone	Red PTFE/Silicone	Red PTFE/Silicone
Durometer	45A	45A	50A	50A
Thickness	0.040" (1mm)	0.040" (1mm)	0.040" (1mm)	0.040" (1mm)
Colour	BLUE - OTHER COLOURS AVAILABLE	CLEAR	CLEAR	CLEAR
Slit				•

BLUE PTFE / SILICONE W/ SLIT



P/N: /100	C270CBS-11	C270CBS-11X	C270CS-11SXB	C270BBS-11X
Septa	Blue PTFE/Silicone	Blue PTFE/Silicone	Blue PTFE/Silicone	Blue PTFE/Silicone
Durometer	50A	50A	50A	50A
Thickness	0.040" (1mm)	0.040" (1mm)	0.040" (1mm)	0.040" (1mm)
Colour	CLEAR - OTHER COLOURS AVAILABLE	CLEAR	BLUE	DARK BLUE
Slit	•	• (Cross Slit)	• (Cross Slit)	• (Cross Slit)





RED PTFE / SILICONE W/ SLIT

P/N: /100	C270CS-11	C270BS-11
Septa	Red PTFE/Silicone	Red PTFE/Silicone
Durometer	50A	50A
Thickness	0.040" (1mm)	0.040" (1mm)
Colour	CLEAR	BLUE
Slit	•	•

CLEAR PVDC: PTFE FREE

P/N: /100	C289-11C	C289S-11C
Septa	PVDC: PTFE Free	PVDC: PTFE Free
Durometer	43A	43A
Thickness	0.040" (1mm)	0.040" (1mm)
Colour	CLEAR	CLEAR
Slit		•



Note: For analytes where PTFE interferes with the sample, such as PFOS, PFOA, etc.

POLYPROPYLENE (PP) / SILICONE



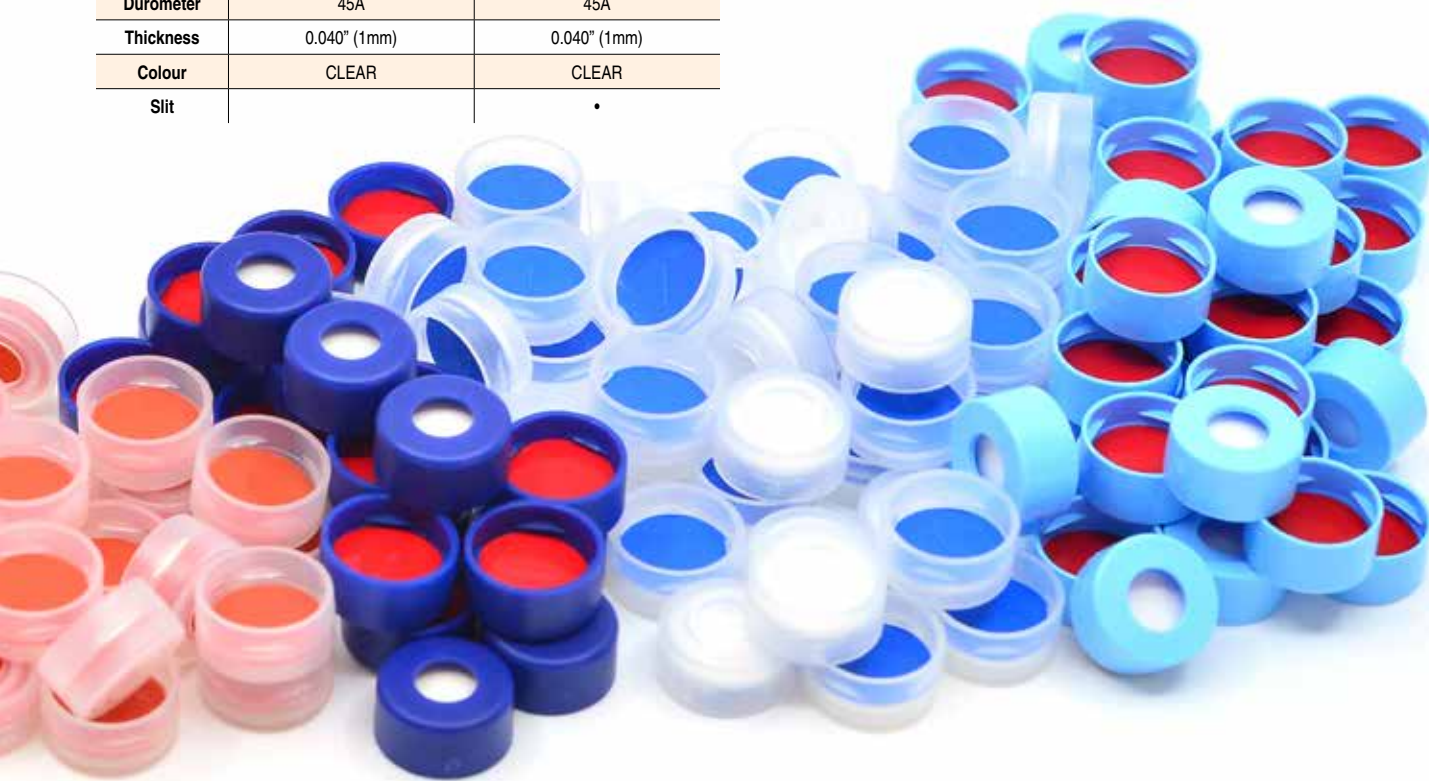

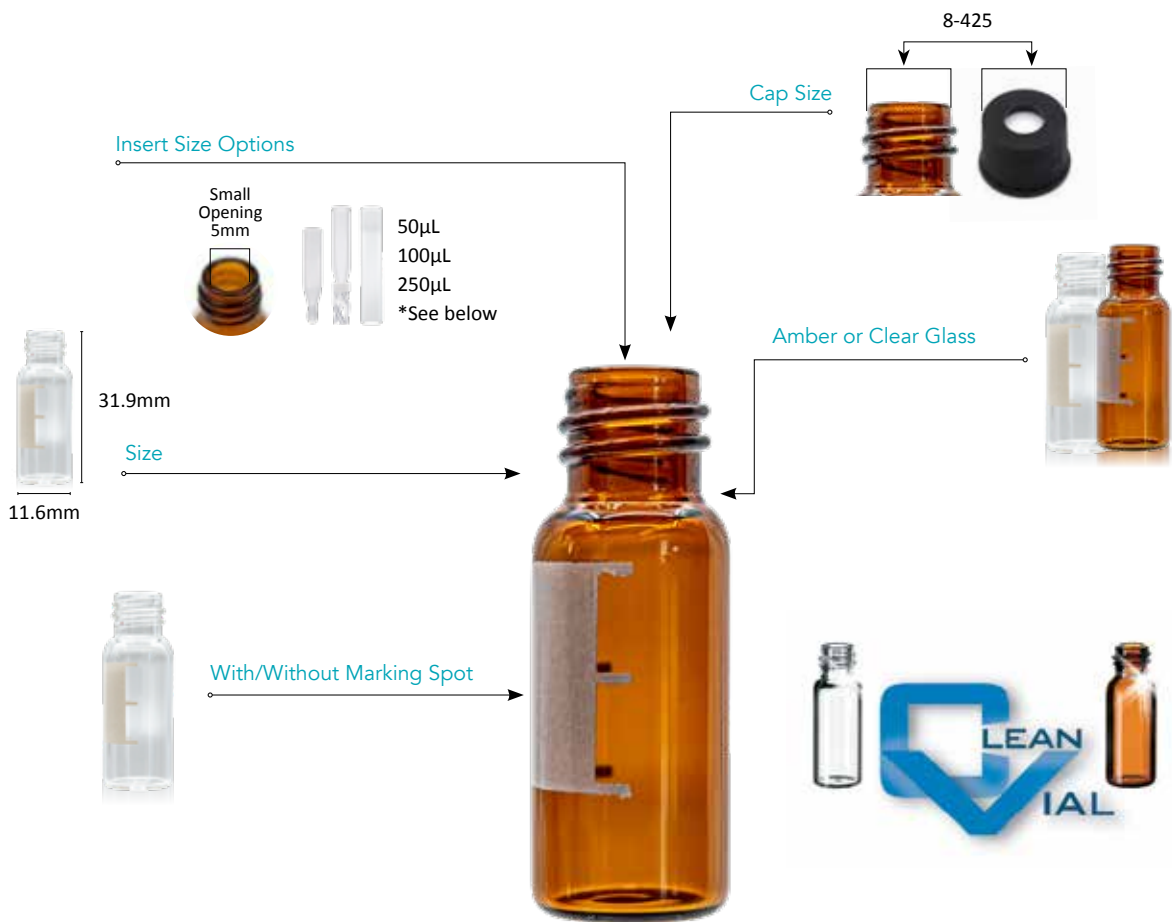

P/N: /100	C290-11	C290-11S
Septa	PP/Silicone	PP/Silicone
Durometer	45A	45A
Thickness	0.040" (1mm)	0.040" (1mm)
Colour	CLEAR	CLEAR
Slit		•





ND 8 2ML SCREW TOP VIALS & CAPS (11.6 x 31.9mm)



SMALL OPENING (5mm) MICRO INSERTS

						
P/N: /100		I005BS-625	I01-531	I01BS-530	I025-531	I01PBS-530
Material		Glass	Glass	Glass	Glass	Polypropylene
Volume		50µL	100µL	100µL	250µL	100µL
Bottom		Conical Bottom Spring	Conical	Conical Bottom Spring	Flat Bottom	Bottom Spring
Silanzed				I01BS-530S		

2ML SCREW TOP VIALS

		
P/N: /100	VT008M-1232	VT008M-1232A
Clear	•	
Amber		•
Marking Spot	•	•



ND8



ND8 2ML SCREW TOP VIALS & CAPS (11.6 x 31.9mm)

RED PTFE / SILICONE

			
P/N: /100	CLS39939	CLS39939S	C9SF-08W
Septa	Red PTFE/Silicone	Red PTFE/Silicone	Red PTFE/Silicone
Durometer	45A	45A	50A
Thickness	0.060" (1.5mm)	0.060" (1.5mm)	0.060" (1.5mm)
Ribbed	•		•
Slit		•	
Colour	Black	Black	White





8-425 OPEN CAP & SEPTAS

			
P/N: /100	C310-08	S04050-08	S04050B-08
Septa	Open Hole	Red PTFE/Silicone	Blue PTFE/Silicone
Durometer	N/A	45A	45A
Thickness	N/A	0.060" (1.5mm)	0.060" (1.5mm)
Ribbed	•		
Colour	Black		

8-425 CLOSED CAP

	
P/N: /100	C360-08BL
Septa	Closed Cap
Durometer	N/A
Thickness	0.050" (1.3mm)
Ribbed	•
Colour	Black









ND8 SCREW TOP 2 ML VIAL & CAP KITS

			
	/100 pcs	VT008M-1232	VT008M-1232A
	CLS39939	VT008M/CLS39939	VT008MA/CLS39939
	CLS39939S	VT008M/CLS39939S	VT008MA/CLS39939S

ND 10 2ML SCREW TOP VIALS & CAPS (11.6 x 31.9mm)



MICRO INSERTS

								
P/N: /100	I025-629	I025BS-629	I025-630	I025CP-631	I025GF-631	I025PBS-629	I025PFT-629	I025P-631
Material	Glass	Glass	Glass	Glass	Glass	Polypropylene	Polypropylene	Polypropylene
Volume	250µL	250µL	350µL	250µL	250µL	250µL	250µL	250µL
Bottom	Conical	Conical Bottom Spring	Flat	Conical	Conical Hanging	Conical Bottom Spring	Integrated Spring	Conical
Silanized		I025BS-629S						

2ML SCREW TOP VIALS



P/N: /100	VT010M-1232	VT010M-1232A
Clear	•	
Amber		•
Marking Spot	•	•



RED PTFE / SILICONE



P/N: /100	C06050-10S	C9SF-010BS
Septa	Red PTFE/Silicone	Red PTFE/Silicone
Durometer	45A	50A
Thickness	0.060" (1.5mm)	0.060" (1.5mm)
Ribbed	•	•
Slit	•	•
Colour	Black	Blue

TAN PTFE / SILICONE BONDED



P/N: /100	C06050BC-10
Septa	TAN PTFE/Silicone
Durometer	45A
Thickness	0.060" (1.5mm)
Ribbed	•
Slit	
Colour	Black

ND10 2ML SCREW TOP VIAL & CAP KIT



/100 pcs



VT010M-1232





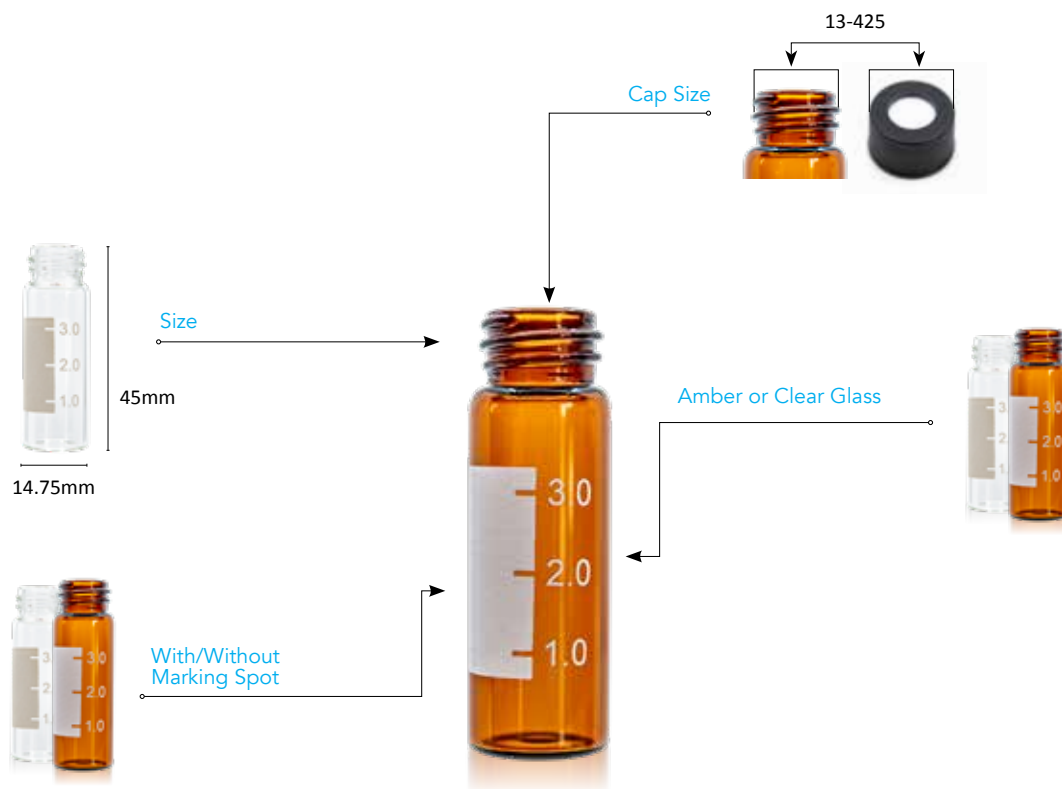

C06050BC-10

VT010M/C06050BC

ND 13 4ML SCREW TOP VIALS, CAPS & 1ML SHELL VIALS



4ML SCREW TOP VIALS

				
P/N: /100	VF013-1545	VF013A-1545	VF013MM-1545	VF013MA-1545
Clear	•		•	
Amber		•		•
Marking Spot	•	•	•	•

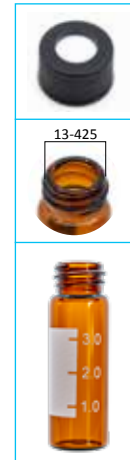

RED PTFE / SILICONE

	
P/N: /100	C06050-13
Septa	Red PTFE/Silicone
Durometer	45A
Thickness	0.060" (1.5mm)
Ribbed	•
Colour	Black



TAN PTFE / SILICONE

	
P/N: /100	C06050-13SBL
Septa	Tan PTFE/Silicone
Durometer	45A
Thickness	0.060" (1.5mm)
Ribbed	•
Colour	Black



PTFE / F217 CLOSED CAP

	
P/N: /100	C360-13W
Septa	PTFE/F217
Durometer	N/A
Thickness	0.050" (1.3mm)
Ribbed	•
Colour	White

4ML PRE-ASSEMBLED VIAL & CAP KITS

		
/100 pcs	VF013A-1545	VF013-1545
C360-13W	8340536013AW-1545	8340536013W-1545
C06050-13		8340C0605013-1545
C06050S-13SBL	8340C06050S13SBL-1545A	

1ML SHELL VIALS W/ PLUG CAPS

		
P/N: /100	V800-840AQ	V800-840Q
Clear		•
Amber	•	

ND 8 CRIMP TOP MICRO VIALS

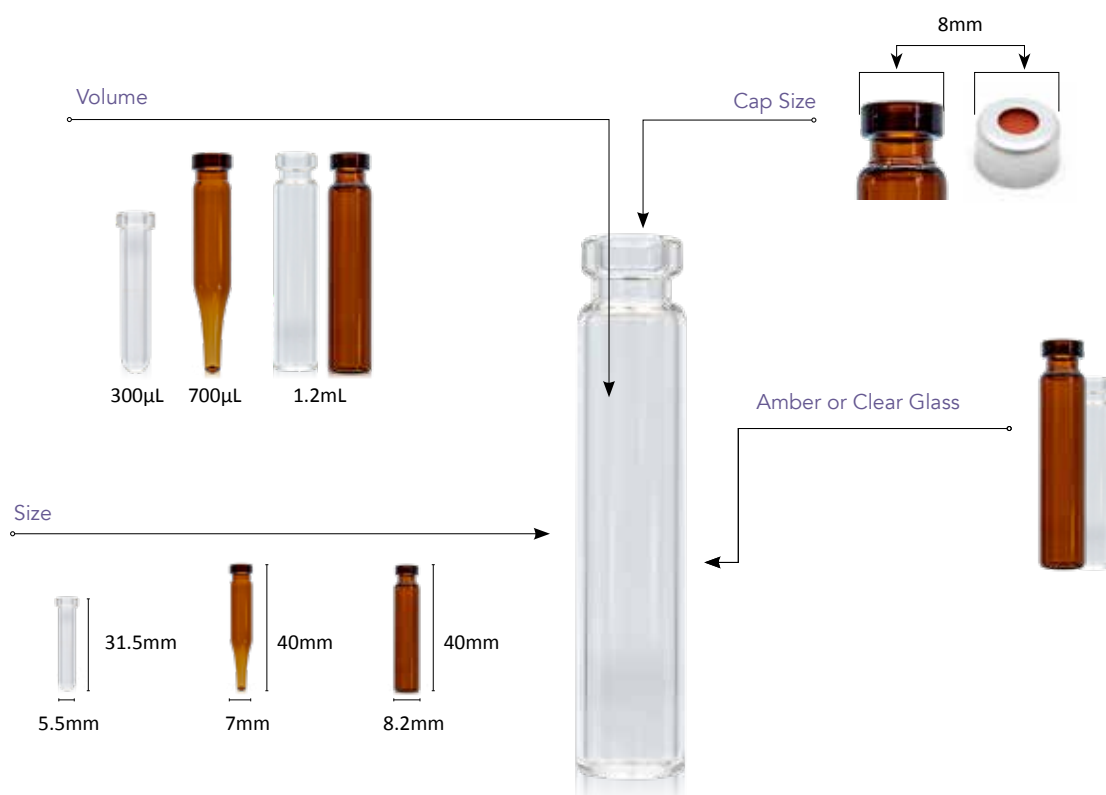

8MM CRIMP CAP MICRO VIALS

				
P/N: /100	V0308-632	V0708-840A	V0808-840A	V0808-840
Volume	300µL	700µL	1.2mL	1.2mL
Clear	•		•	•
Amber		•		
Width	5.5mm	7mm	8.2mm	8.2mm
Length	31.5mm	40mm	40mm	40mm



FEP / RED SILICONE

	
P/N: /100	C141-08
Septa	FEP / Red Silicone
Durometer	50A
Thickness	0.040" (1mm)

RED PTFE / SILICONE

	
P/N: /100	C150P-08
Septa	RED PTFE/Silicone
Durometer	50A
Thickness	0.040" (1mm)

PTFE / SILICONE / RED PTFE

	
P/N: /100	C160-08
Septa	PTFE / Silicone / PTFE
Durometer	50A
Thickness	0.040" (1mm)



ND 18 10ML & 20ML HEADSPACE SCREW TOP VIALS





10ML SCREW TOP VIALS

			
P/N: /100	VX0018-2346S	VX0018A-2346S	VX0018-2346CTC
Volume	10mL	10mL	10mL
Clear	•		•
Amber		•	
Bottom	Flat	Flat	Round
Width	22.5mm	22.5mm	22.5mm
Length	46mm	46mm	46mm

* Suitable for SPME

20ML SCREW TOP VIALS

			
P/N: /100	VXX018-2375S	VXX018A-2375S	VXX018-2375CTC
Volume	20mL	20mL	20mL
Clear	•		•
Amber		•	
Bottom	Flat	Flat	Round
Width	22.5mm	22.5mm	22.5mm
Length	75.5mm	75.5mm	75.5mm

* Suitable for SPME

ND 18 10ML & 20ML HEADSPACE SCREW TOP VIALS

BLUE PTFE / WHITE SILICONE



P/N: /100	CHR-1414
Septa	Blue PTFE/White Silicone
Durometer	55A
Thickness	0.060" (1.5mm)
Magnetic	•

GREY PTFE / RED BUTYL



P/N: /100	CHR-1416
Septa	Grey PTFE / Red Butyl
Durometer	55A
Thickness	0.060" (1.5mm)
Magnetic	•

RED PTFE / SILICONE



P/N: /100	CHR-1578
Septa	Red PTFE/Silicone
Durometer	45A
Thickness	0.050" (1.25mm)
Magnetic	•

WHITE PTFE / TRANSLUCENT BLUE SILICONE (SPME)



P/N: /100	CLS-1309
Septa	White PTFE/Translucent Blue Silicone
Durometer	38A
Thickness	0.050" (1.25mm)
Magnetic	•

RED PTFE / SILICONE



P/N: /100	CLS-1412
Septa	Red PTFE/Silicone
Durometer	60A
Thickness	0.040" (1mm)
Magnetic	•





VIAL & CAP KITS



/100 pcs



VX0018-2346CTC



VXX018-2375CTC



CHR-1416

VX0018CTC-CHR1416L

VXX018CTC-CHR1416L



CHR-1578

VX0018CTC-CHR1578

VXX018CTC-CHR1578

ND 20 6ML, 10ML & 20ML HEADSPACE CRIMP TOP VIALS



6ML CRIMP TOP VIALS



P/N: /100	V06020-2338X
Volume	6mL
Clear	•
Amber	
Bottom	Flat
Width	21.75
Length	38
Instrument	KARL FISHER OVEN

10ML CRIMP TOP VIALS



P/N: /100	VX0020-2346X	VX0020AB-2346X	VX0020-2346CTC	VX0020SPME-2346	VX0020ASPME-2346
Volume	10mL	10mL	10mL	10mL	10mL
Clear	•		•	•	
Amber		•			•
Bottom	Flat	Round	Round	Round	Round
Width	22.5mm	22.5mm	22.5mm	22.5mm	22.5mm
Length	46mm	46mm	46mm	46mm	46mm
Instrument	Various	Various	CTC	SPME Analysis	



20 mm



20ML CRIMP TOP VIALS



P/N: /100	VXX020-2375X	VXX020A-2375X	VXX020PE-2375	VXX020-2375CTC	VXX020SPME-2375	VXX020ASPME-2375
Volume	20mL	20mL	20mL	20mL	20mL	20mL
Clear	•		•	•	•	
Amber		•				•
Bottom	Flat	Flat	Flat	Round	Round	Round
Width	22.5mm	22.5mm	22.5mm	22.5mm	22.5mm	22.5mm
Length	75.5mm	75.5mm	75.5mm	75.5mm	75.5mm	75.5mm
Instrument	Various	Various	PerkinElmer	CTC	SPME Analysis	

PTFE / BUTYL (Pharma-Fix)



P/N: /100	CHR-0030
Septa	PTFE/Butyl
Durometer	50A
Thickness	0.125" (3.05mm)
Pressure Release	
Colour	Silver
Instrument	Various

PTFE / BUTYL (Pharma-Fix)



P/N: /100	CHR-0031
Septa	PTFE/Butyl
Durometer	50A
Thickness	0.125" (3.05mm)
Pressure Release	•
Colour	Silver
Instrument	Various

TRANSPARENT BLUE SILICONE



P/N: /100	CLS-9508
Septa	Transparent Blue Silicone
Durometer	50A
Thickness	0.125" (3.05mm)
Pressure Release	
Colour	Silver
Instrument	Various

PTFE / SILICONE



P/N: /100	CLS-9980	CLS-9981
Septa	ULB PTFE/Silicone	ULB PTFE/Silicone
Durometer	50A	50A
Thickness	0.125" (3.05mm)	0.125" (3.05mm)
Pressure Release	•	
Colour	Silver	Silver
Instrument	PerkinElmer	Agilent

SPME MAGNETIC

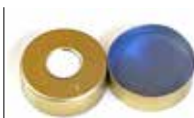

P/N: /100	CHR-0053
Septa	Blue PTFE/Silicone
Durometer	N/A
Thickness	N/A
Pressure Release	
Colour	Gold
Instrument	Various

POLYETHYLENE WASH



P/N: /100	CHR-1334
Septa	PTFE/Silicone
Durometer	N/A
Thickness	N/A
Pressure Release	
Colour	Clear
Instrument	CTC/Leap/Gerstel

MAGNETIC TAN PTFE / SILICONE



P/N: /100	CLS-1535B	CLS-1535R	CLS-1536G	CLS-1536GO	CLS-1536S
Septa	ULB Tan PTFE/Silicone	ULB Tan PTFE/Silicone	PTFE/Silicone	PTFE/Silicone	PTFE/Silicone
Durometer	50A	50A	50A	50A	50A
Thickness	0.125" (3.05mm)	0.125" (3.05mm)	0.125" (3.05mm)	0.125" (3.05mm)	0.125" (3.05mm)
Magnetic	•	•	•	•	•
Colour	Blue	Red	Green	Gold	Silver
Instrument	CTC/Leap/Gerstel	CTC/Leap/Gerstel	CTC/Leap/Gerstel	CTC/Leap/Gerstel	CTC/Leap/Gerstel



VIAL & CAP KITS



/100 PCS



VXX020-2375CTC



VXX020PE-2375



CLS-9981

VXX020PE-CLS9981



CLS-1535B

VXX020CTC-CLS1535B

CRIMPERS / DECAPPERS & SAMPLE HANDLING TOOLS

SAMPLE HANDLING TOOLS*

Oxford Accupet Evo



Pipet Tips

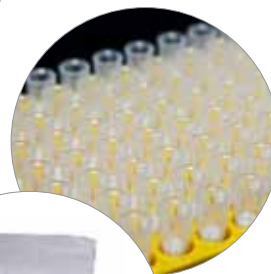

Bottle Top Dispenser



*Please enquire

Hand Operated Crimper
CR00-11



Easy Grip Crimper
CR311990



Electronic Crimper
CR6A11C0

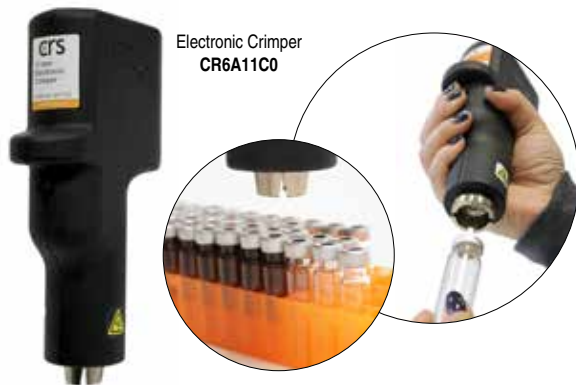

High Power Electronic Crimper
CR6AHPS0



Crimper Jaw Set
CR311955

Electronic crimpers and decappers fit standard laboratory vials and seals with aluminum or two-part aluminum/steel caps. The electronically adjustable cycle is accurate and reproducible and can be adjusted with the control pad on top of the unit. The tools are ergonomically designed to reduce strain and arm injury associated with many manual crimping tools. (Such as Carpal Tunnel Syndrome).

MANUAL CRIMPER & DECAPPERS

	8mm	11mm	20mm
Hand Operated Crimper	CR00-08	CR00-11	CR00-20
Easy Grip Crimper	CR308990	CR311990	CR320990
Hand Operated DeCapper	CR10-08		
Easy Grip DeCapper		CR311991	CR320991

ELECTRONIC BATTERY POWERED CRIMPER & DECAPPERS (Includes battery and charging cable)

	8mm	11mm	20mm
Electronic Crimper	CR6A08C0	CR6A11C0	CR6A20C0
Electronic Decapper		CR6A11D0	CR6A20D0
6.4 Volt LiFePO4 Battery		CRHPB6-A	

ELECTRONIC PLUG-IN CRIMPER & DECAPPERS

	8mm	11mm	20mm
High Power Electronic Crimper with plug-in power (Jaw sets sold separately below)		CR6AHPS0	
Crimper Jaw Set	CR308955	CR311955	CR320955
Decapper Jaw Set		CR311965	CR320965
Base for Electronic Crimping Tools		CR5ABAS0	

STORAGE / DRAM VIALS & CAPS



ND9 2ML SCREW TOP VIALS

P/N: /100	VT009-1232	VT009A-1232	VT009M-1232	VT009M-1232A
Clear	•		•	
Amber		•		•
Marking Spot			•	•
Width	11.6	11.6	11.6	11.6
Height	31.9	31.9	31.9	31.9

ND9 PTFE / CLOSED CAP

P/N: /100	C398C-09BL
Septa	PTFE
Durometer	N/A
Thickness	0.050" (1.3mm)
Ribbed	•
Colour	Black



STORAGE / DRAM VIALS AND CAPS

ND13 4ML SCREW TOP VIALS (1 DRAM)

P/N: /100	VF013-1545	VF013A-1545	VF013MM-1545	VF013MA-1545
Clear	•		•	
Amber		•		•
Marking Spot			•	•
Width	14.75mm	14.75mm	14.75mm	14.75mm
Height	45mm	45mm	45mm	45mm

ND13 PTFE / F217 CLOSED CAP

P/N: /100	C360-13W
Septa	PTFE/F217
Durometer	N/A
Thickness	0.050" (1.3mm)
Ribbed	•
Colour	White

ND15 7ML SCREW TOP VIALS (2 DRAM)

P/N: /100	VS015-1760X	VS015A-1760X
Clear	•	
Amber		•
Width	16.6mm	16.6mm
Height	61mm	61mm

ND15 PTFE / F217 CLOSED CAP

P/N: /100	C360-15W
Septa	PTFE/F217
Durometer	N/A
Thickness	0.050" (1.3mm)
Ribbed	•
Colour	White

STORAGE / DRAM VIALS & CAPS

ND15 10ML SCREW TOP VIALS (3 DRAM)



P/N: /100	VX2015-1965X	VX2015A-1965X
Clear	•	
Amber		•
Width	18.5mm	18.5mm
Height	66mm	66mm

ND15 PTFE / F217 CLOSED CAP



P/N: /100	C360-15W
Septa	PTFE/F217
Durometer	N/A
Thickness	0.050" (1.3mm)
Ribbed	•
Colour	White

ND18 15ML SCREW TOP VIALS (4 DRAM)



P/N: /100	V16018-2170X	V16018A-2170X
Clear	•	
Amber		•
Width	20.6mm	20.6mm
Height	71mm	71mm

ND18 PTFE / F217 CLOSED CAP



P/N: /100	C360-18W
Septa	PTFE/F217
Durometer	N/A
Thickness	0.050" (1.3mm)
Ribbed	•
Colour	White

4ML & 7ML PRE-ASSEMBLED VIAL & CAP KITS

				
/100 pcs	VF013-1545	VF013A-1545	VS015-1760X	VS015A-1760X
	C360-13W	8340536013W-1545	8340536013AW-1545	
	C360-15W		8VS05360-15W	8VS05360-15AW



10ML & 15ML PRE-ASSEMBLED VIAL & CAP KITS

				
/100 pcs	VX2015-1965X	VX2015A-1965X	V16018-2170X	V16018A-2170X
	C360-15W	8V2015360-15W	8V2015360-15AW	
	C360-18W		8V165360-18W	8V018360-18AW

EPA VIALS & CAPS



Volume	20mL	20mL	40mL	40mL	60mL	60mL
Clear	•		•		•	
Amber		•		•		•



EPA Vials with O/H Septa Cap

Pre-Cleaned	320C12572-2	320A12572-2	340C12572-2	340A12572-2	360C12572-2	360A12572-2
Non Pre-Cleaned	N/A	N/A	340C12572-1	340A12572-1	N/A	N/A





EPA Vials with Closed Cap

Pre-Cleaned	320C01572-2	320A01572-2	340C01572-2	340A01572-2	360C01572-2	360A01572-2
Non Pre-Cleaned	N/A	N/A	340C01572-1	340A01572-1	N/A	N/A

EPA Vial Only

Non Pre-Cleaned	320/100	320A/100	340/100	340A/100	360/100	360A/100
-----------------	---------	----------	---------	----------	---------	----------

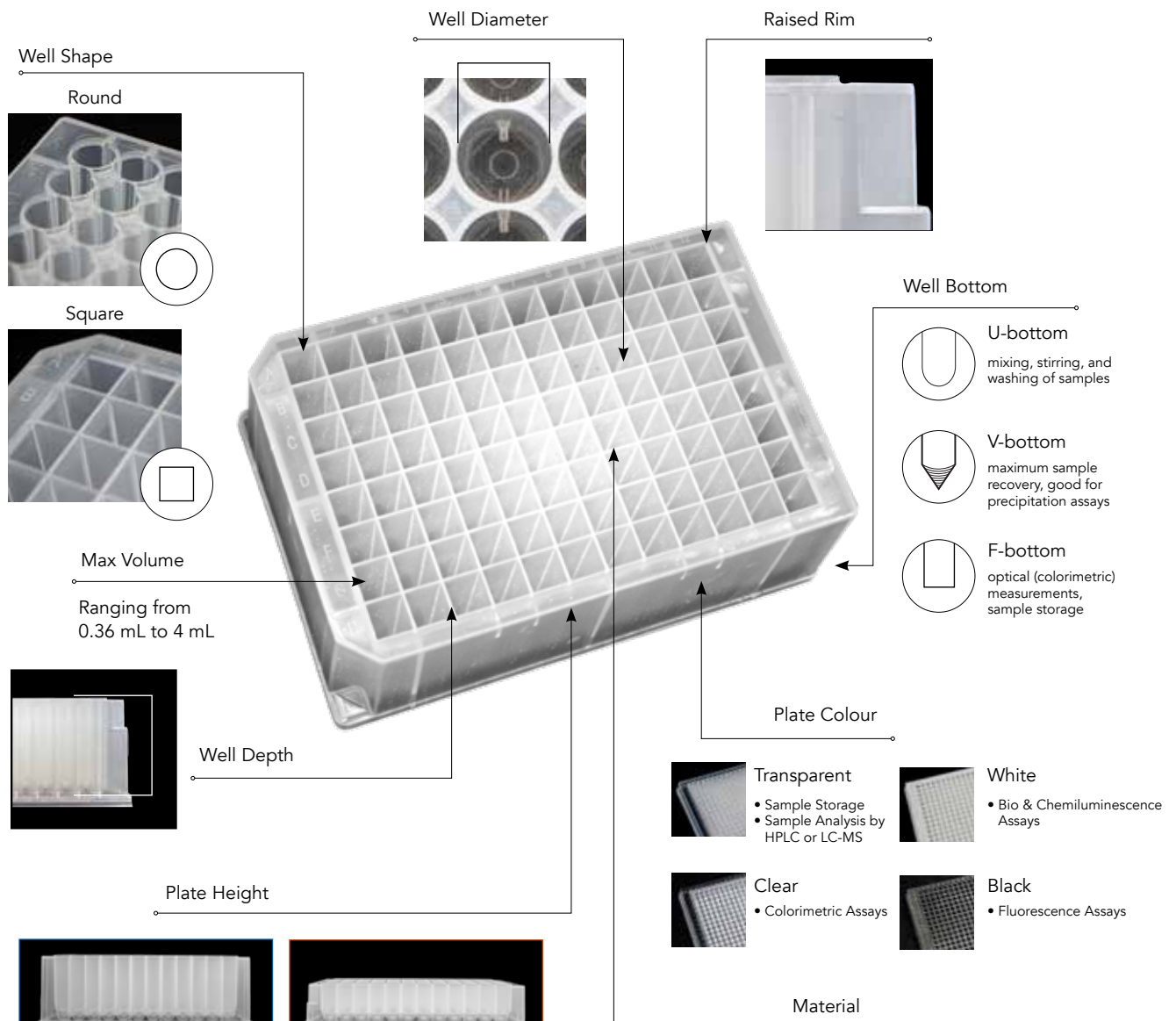
ASSAY & STORAGE PLATES

Deep Well

- Common Applications**
- Sample Storage
 - HPLC & LC-MS Sample Analysis



Medium Well

- Common Applications**
- Sample Storage
 - HPLC & LC-MS Sample Analysis
 - Smaller Sample Volumes
 - Space Saving Applications



Shallow Well

- Common Applications**
- ELISA Assays
 - Optical Measurements (colorimetric)
 - Microscopic Analysis
 - Sample Storage



Seed Genomics

- Common Applications**
- Plant and Seed Genomics



Magnetic Plates

- Common Applications**
- Magnetic Separation Technology
- Suitable for:**
- KingFisher™ 96 Flex Magnetic Particle Processors
 - Qiagen: Bio Sprint 96



Polystyrene (PS)

Properties

- Clear – transmits light well
- Amenable to physical surface treatments and coatings

Common Applications

- ELISA assays
- Optical measurements (colorimetric)
- Microscopic analysis



Polypropylene (PP)

Properties

- High chemical resistance (e.g. DMSO)
- High thermal stability (-196 °C to +121 °C)
- Low binding of proteins & DNA/RNA vs. PS
- Transparent – transmits less light than PS

Common Applications

- Sample storage
- HPLC & LC-MS sample analysis

DEEP WELL ASSAY & STORAGE PLATES

• Sample Storage • HPLC & LC-MS Sample Analysis



P/N: /50	PCH-RU004-1ML
WORKING VOLUME	1.0mL
MATERIAL	Polypropylene
SHAPE	ROUND
BOTTOM	U
W. DEPTH (mm)	39.2
W. DIAMETER (mm)	7
CAP MAT (Non Slit)	IS07-9613
CAP MAT (Slit)	IS07-9614

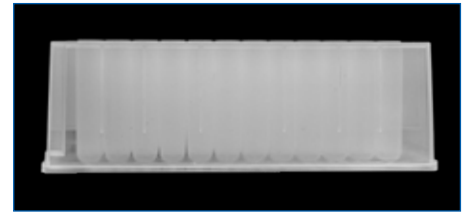
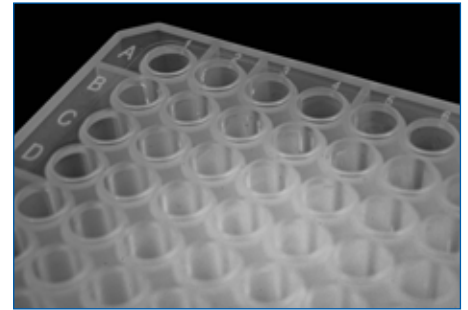
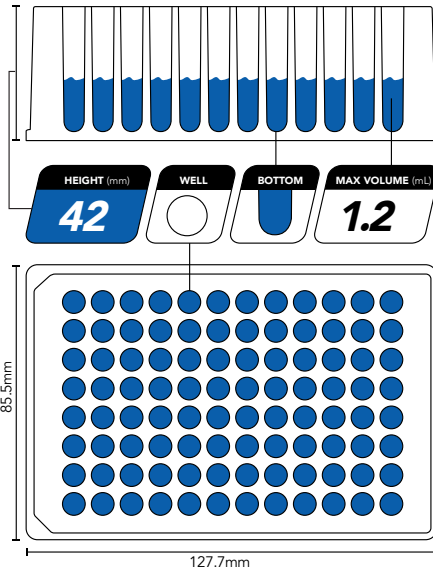

P/N: /50	PCH-RU004B-1ML
WORKING VOLUME	1.0mL
MATERIAL	Polypropylene
SHAPE	ROUND
BOTTOM	U
W. DEPTH (mm)	39.2
W. DIAMETER (mm)	7
CAP MAT (Non Slit)	IS07-9613
CAP MAT (Slit)	IS07-9614

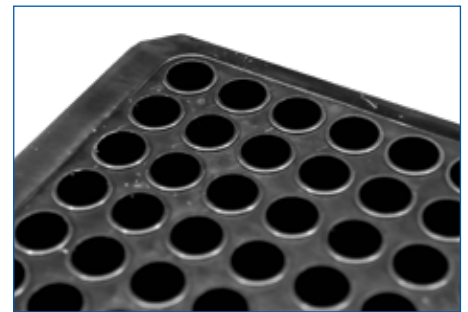
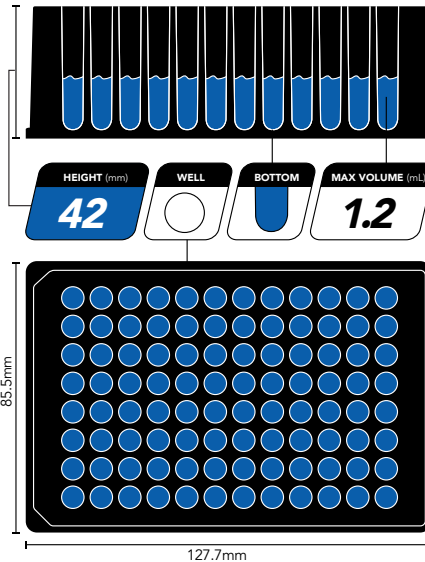

P/N: /50	PCH-RU006-2ML
WORKING VOLUME	2.0mL
MATERIAL	Polypropylene
SHAPE	ROUND
BOTTOM	U
W. DEPTH (mm)	41.9
W. DIAMETER (mm)	8.5
CAP MAT (Non Slit)	IS07-9913
CAP MAT (Slit)	IS07-9914

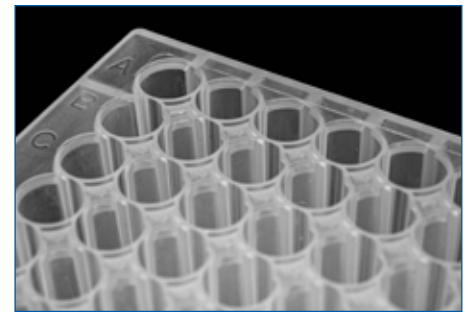
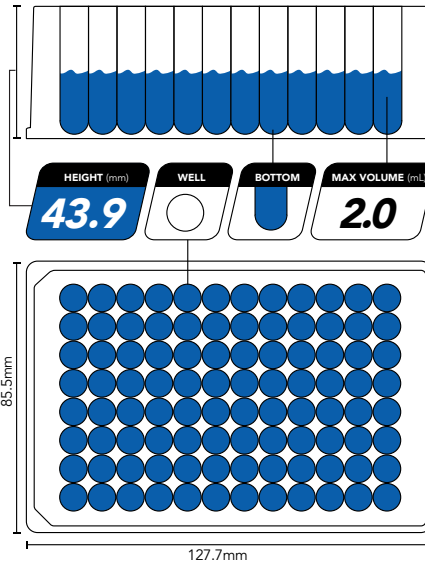



P/N: /50	PCH-SV003-2ML
WORKING VOLUME	2.0mL
MATERIAL	Polypropylene
SHAPE	SQUARE
BOTTOM	V
W. DEPTH (mm)	39.9
W. DIAMETER (mm)	8.24
CAP MAT (Non Slit)	IS07-9611
CAP MAT (Slit)	IS07-9612

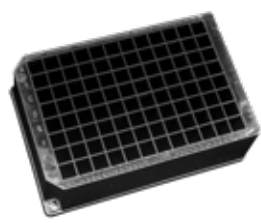
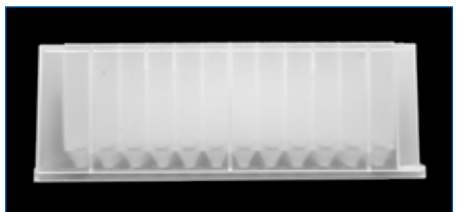
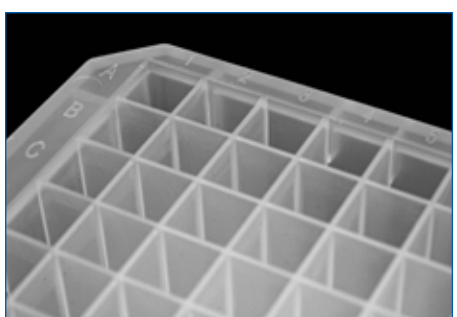
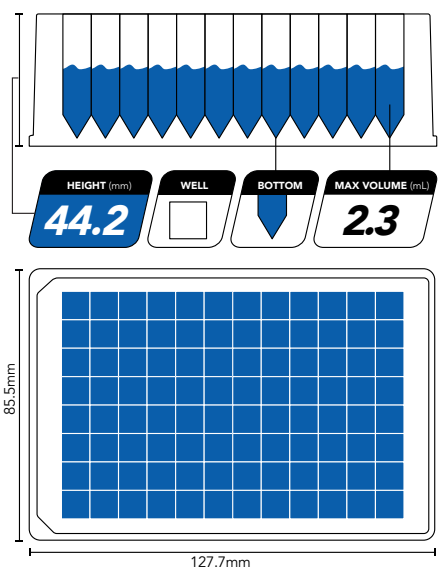

P/N: /50	PCH-SV003B-2ML
WORKING VOLUME	2.0mL
MATERIAL	Polypropylene
SHAPE	SQUARE
BOTTOM	V
W. DEPTH (mm)	39.9
W. DIAMETER (mm)	8.24
CAP MAT (Non Slit)	IS07-9611
CAP MAT (Slit)	IS07-9612

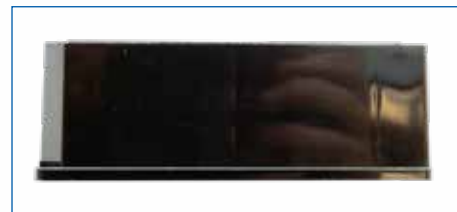
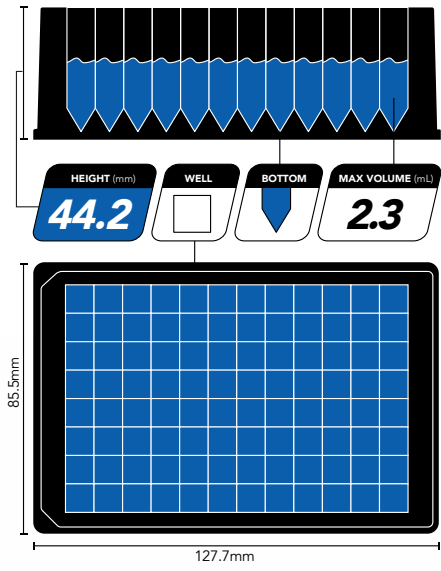

DEEP WELL ASSAY & STORAGE PLATES



P/N: /50	PCH-SU312-2.2ml
WORKING VOLUME	2.2mL
MATERIAL	Polypropylene
SHAPE	SQUARE
BOTTOM	U
W. DEPTH (mm)	39
W. DIAMETER (mm)	8.2
CAP MAT (Non Slit)	IS07-9611
CAP MAT (Slit)	IS07-9612

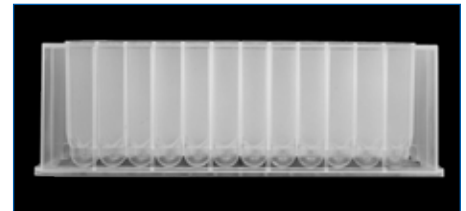
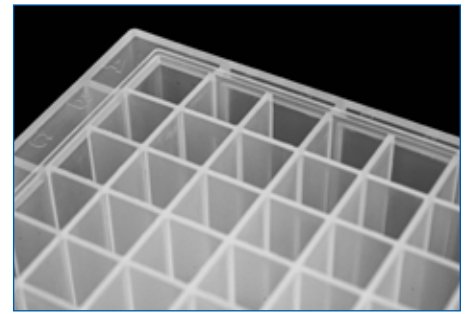
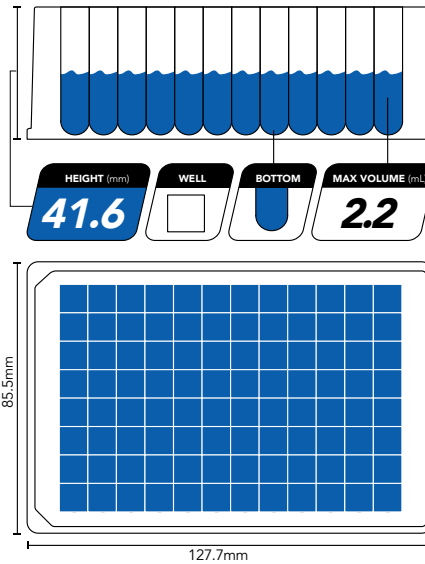

P/N: /50	PCH-SV320-2.2ml
WORKING VOLUME	2.2mL
MATERIAL	Polypropylene
SHAPE	SQUARE
BOTTOM	V
W. DEPTH (mm)	39
W. DIAMETER (mm)	8.2
CAP MAT (Non Slit)	IS07-9611
CAP MAT (Slit)	IS07-9612

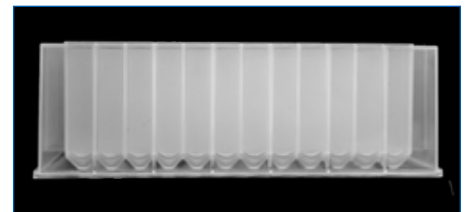
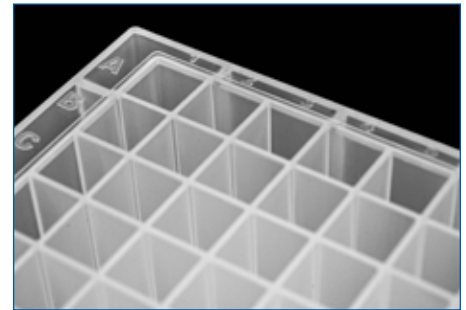
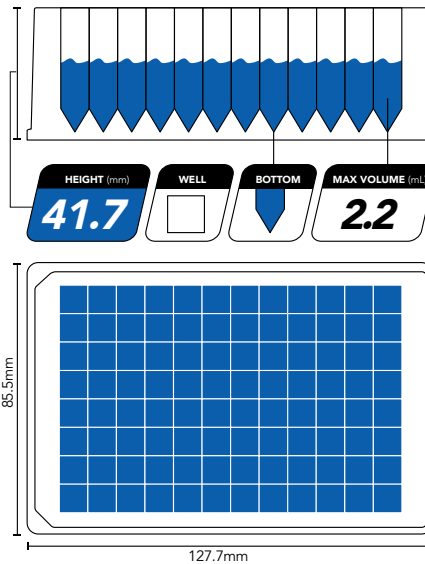

P/N: /20	RT96PPRWC2.5ML
WORKING VOLUME	2.0mL
MATERIAL	Polypropylene
SHAPE	SQUARE
BOTTOM	U
W. DEPTH (mm)	41
W. DIAMETER (mm)	17.2
CAP MAT (Non Slit)	IS07-9611
CAP MAT (Slit)	IS07-9612

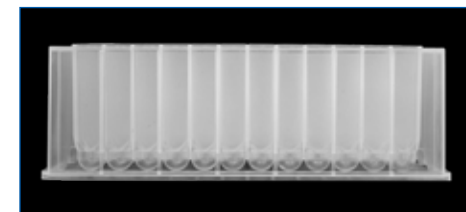
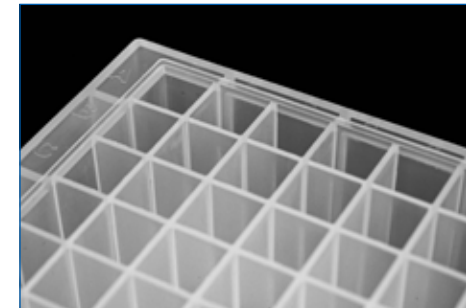
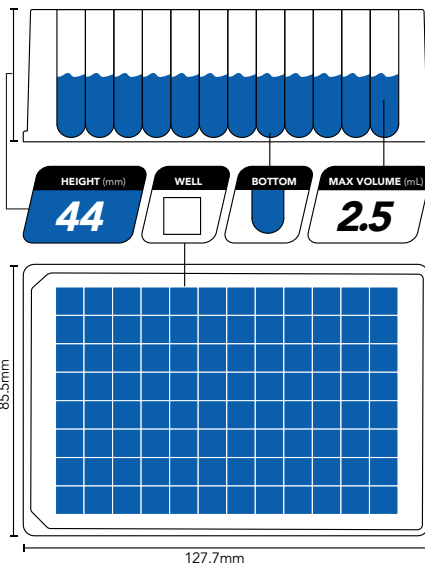



P/N: /50	PCH-RU314-3.5ml
WORKING VOLUME	3.5mL
MATERIAL	Polypropylene
SHAPE	ROUND
BOTTOM	U
W. DEPTH (mm)	40.4
W. DIAMETER (mm)	11.2
CAP MAT	See Plate Seal Guide

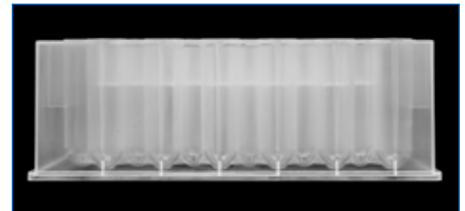
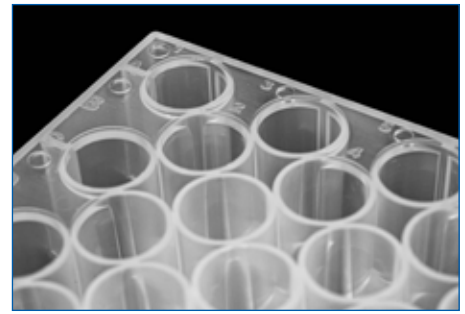
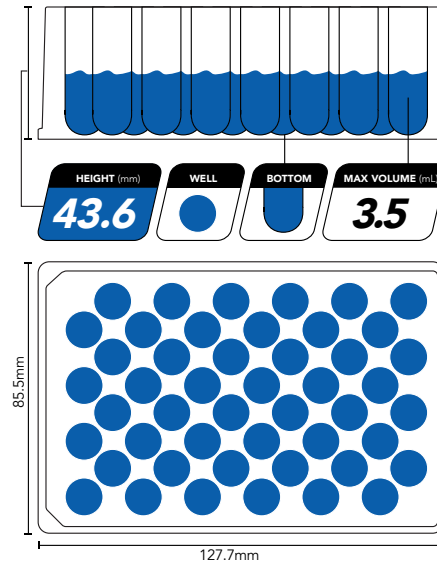

P/N: /50	PCH-SU316-4.6ml
WORKING VOLUME	4.6mL
MATERIAL	Polypropylene
SHAPE	SQUARE
BOTTOM	U
W. DEPTH (mm)	38
W. DIAMETER (mm)	8.2 x 17.2
CAP MAT	See Plate Seal Guide
CAP MAT (EVA)	RT96EVASW5ML

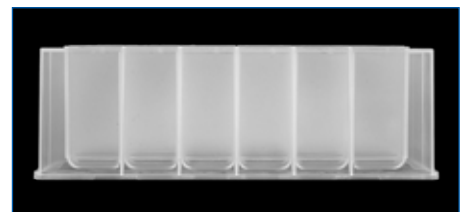
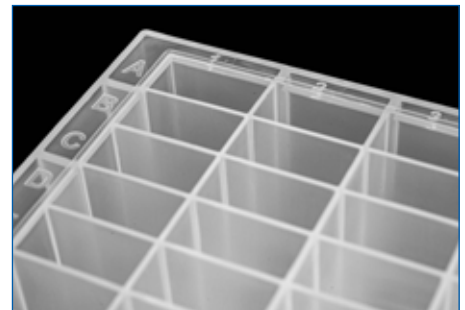
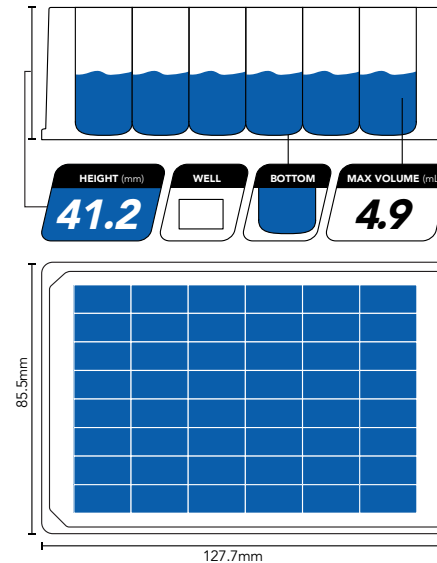

P/N: /50	PCH-SV318-10ML
WORKING VOLUME	10mL
MATERIAL	Polypropylene
SHAPE	SQUARE
BOTTOM	V
W. DEPTH (mm)	41
W. DIAMETER (mm)	17.2
CAP MAT	See Plate Seal Guide
CAP MAT (EVA)	RT96EVASW10ML

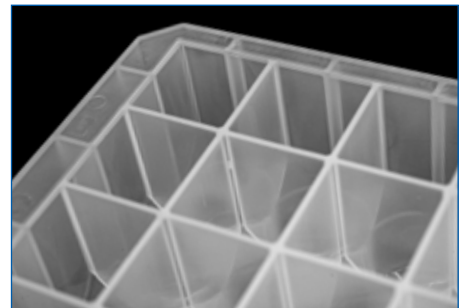
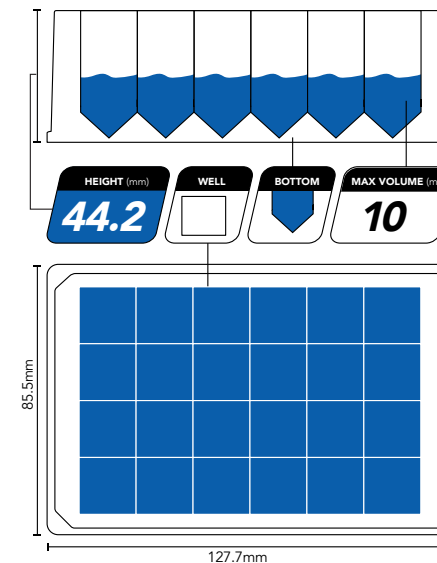

MEDIUM WELL ASSAY & STORAGE PLATES

• Sample Storage • HPLC & LC-MS Sample Analysis • Smaller Sample Volumes • Space Saving Applications



P/N: /40	RT96PPRWC0.5ML
WORKING VOLUME	0.5mL
MATERIAL	Polypropylene
SHAPE	ROUND
BOTTOM	V
W. DEPTH (mm)	N/A
W. DIAMETER (mm)	8.5
CAP MAT (Non Slit)	IS07-9913
CAP MAT (Slit)	IS07-9914

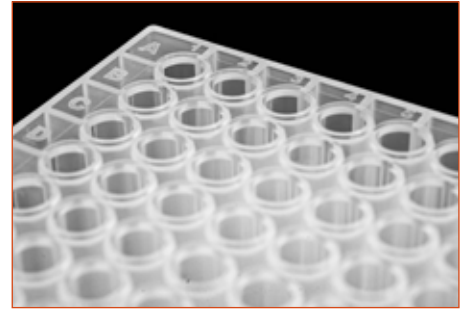
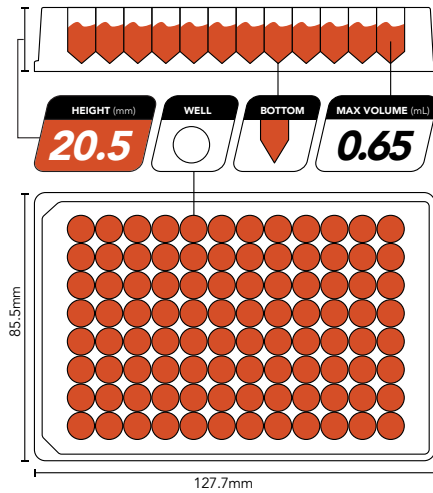

P/N: /50	PCH-RU304-1ML
WORKING VOLUME	1.0mL
MATERIAL	Polypropylene
SHAPE	ROUND
BOTTOM	U
W. DEPTH (mm)	30.8
W. DIAMETER (mm)	7
CAP MAT (Non Slit)	IS07-9613
CAP MAT (Slit)	IS07-9614

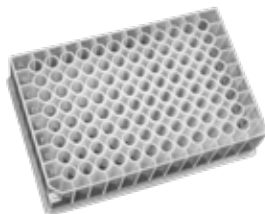
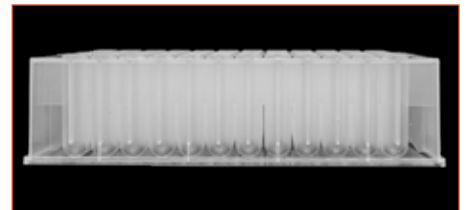
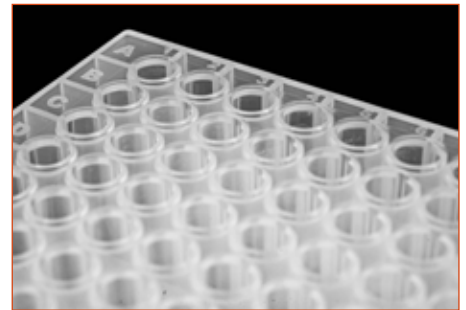
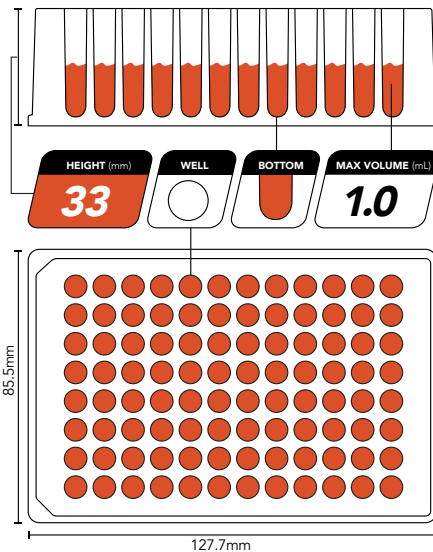

P/N: /50	PCH-RV322-1ML
WORKING VOLUME	1.0mL
MATERIAL	Polypropylene
SHAPE	ROUND
BOTTOM	V
W. DEPTH (mm)	30.8
W. DIAMETER (mm)	7
CAP MAT (Non Slit)	IS07-9613
CAP MAT (Slit)	IS07-9614

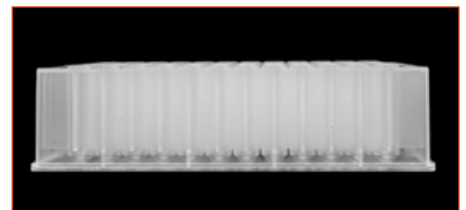
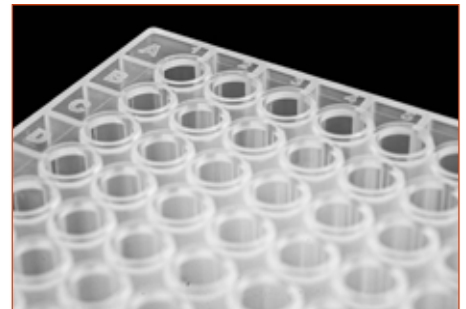
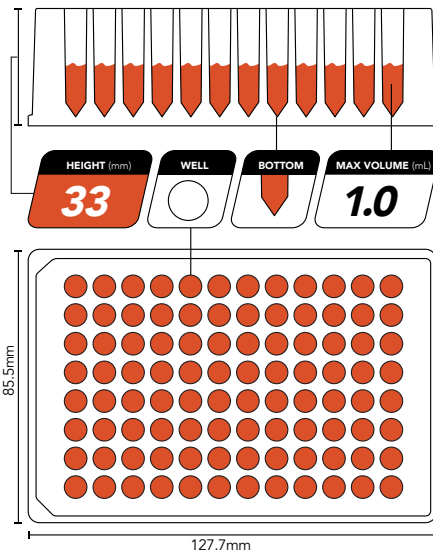



P/N: /50	PCH-SU306-1.2ML
WORKING VOLUME	1.2mL
MATERIAL	Polypropylene
SHAPE	SQUARE
BOTTOM	U
W. DEPTH (mm)	21.6
W. DIAMETER (mm)	8.2
CAP MAT (Non Slit)	IS07-9611
CAP MAT (Slit)	IS07-9612

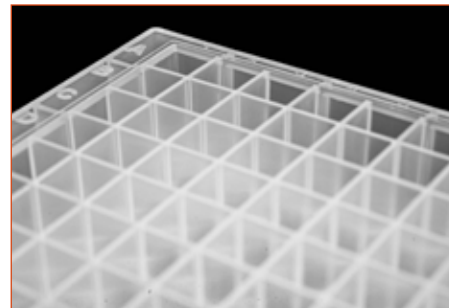
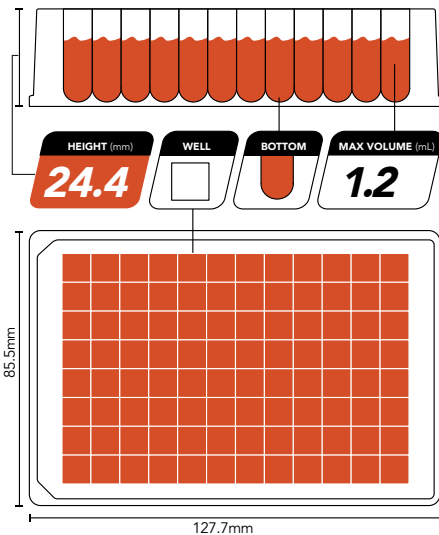

P/N: /50	PCH-SU308-1.6ML
WORKING VOLUME	1.6mL
MATERIAL	Polypropylene
SHAPE	SQUARE
BOTTOM	U
W. DEPTH (mm)	28.5
W. DIAMETER (mm)	8.2
CAP MAT (Non Slit)	IS07-9611
CAP MAT (Slit)	IS07-9612

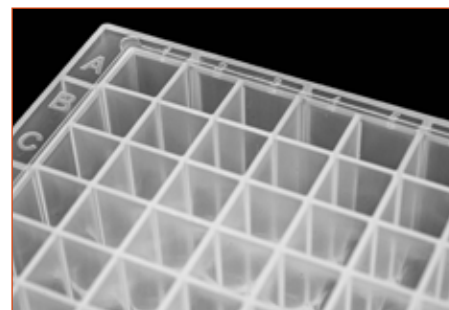
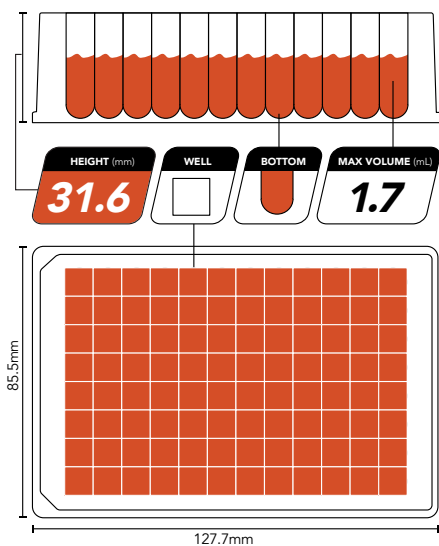

P/N: /50	PCH-SV321-1.6ML
WORKING VOLUME	1.6mL
MATERIAL	Polypropylene
SHAPE	SQUARE
BOTTOM	V
W. DEPTH (mm)	28.8
W. DIAMETER (mm)	8.2
CAP MAT (Non Slit)	IS07-9611
CAP MAT (Slit)	IS07-9612

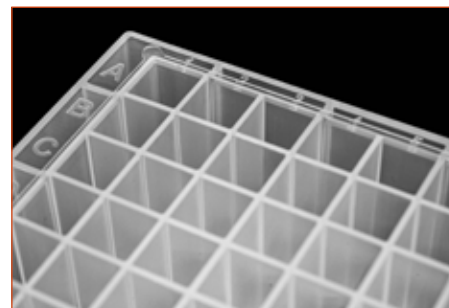
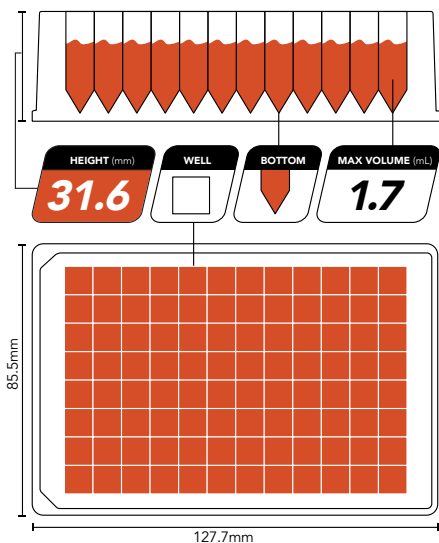

SHALLOW WELL ASSAY & STORAGE PLATES

• ELISA Assays • Optical Measurements (colorimetric) • Microscopic Analysis • Sample Storage



P/N: /100	RT96PSRV240UL
WORKING VOLUME	0.24mL
MATERIAL	Polystyrene
SHAPE	ROUND
BOTTOM	V
W. DEPTH (mm)	11.1
W. DIAMETER (mm)	7
CAP MAT (Non Slit)	IS07-9613
CAP MAT (Slit)	IS07-9614

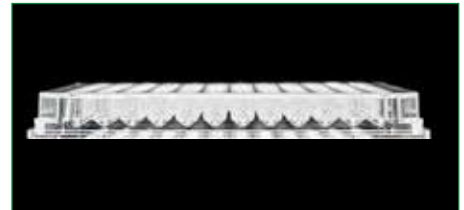
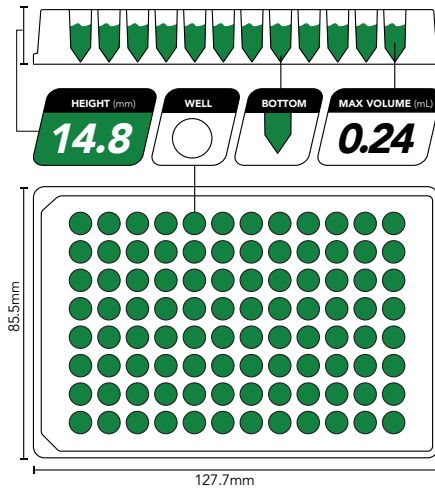

P/N: /64	RT96PPRU300UL
WORKING VOLUME	0.3mL
MATERIAL	Polypropylene
SHAPE	ROUND
BOTTOM	U
W. DEPTH (mm)	11.1
W. DIAMETER (mm)	7
CAP MAT (Non Slit)	IS07-9613
CAP MAT (Slit)	IS07-9614

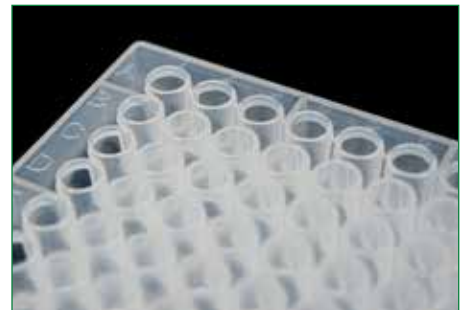
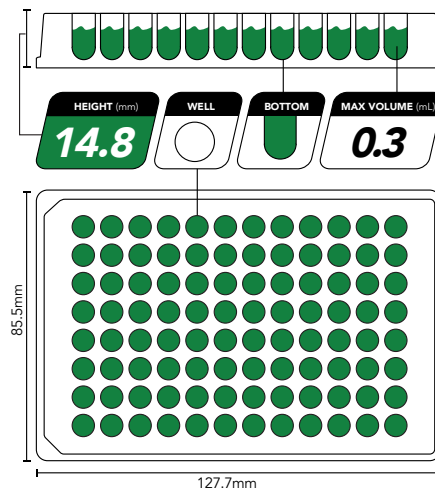

P/N: /100	RT96PSRU300UL
WORKING VOLUME	0.3mL
MATERIAL	Polystyrene
SHAPE	ROUND
BOTTOM	U
W. DEPTH (mm)	11.1
W. DIAMETER (mm)	7
CAP MAT (Non Slit)	IS07-9613
CAP MAT (Slit)	IS07-9614

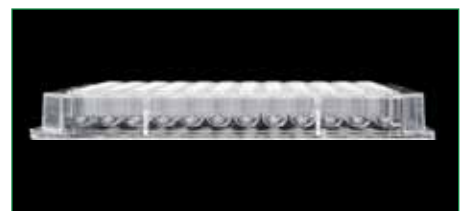
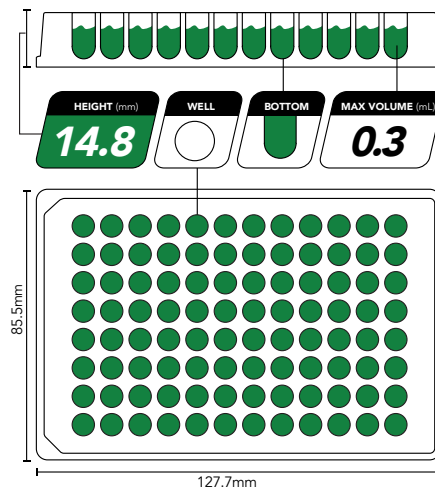



P/N: /100	RT96PPRF350UL
WORKING VOLUME	0.35mL
MATERIAL	Polypropylene
SHAPE	ROUND
BOTTOM	Flat
W. DEPTH (mm)	11.1
W. DIAMETER (mm)	7
CAP MAT (Non Slit)	IS07-9613
CAP MAT (Slit)	IS07-9614

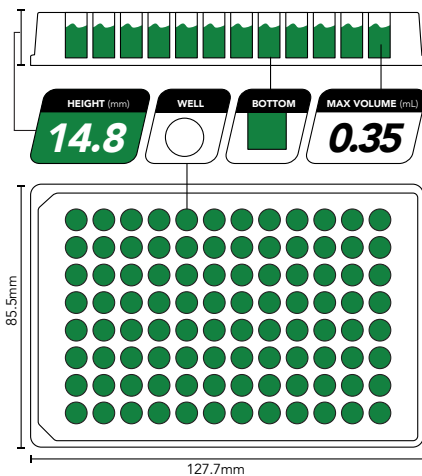

P/N: /100	RT96PSRF350UL
WORKING VOLUME	0.35mL
MATERIAL	Polystyrene
SHAPE	ROUND
BOTTOM	Flat
W. DEPTH (mm)	11.1
W. DIAMETER (mm)	7
CAP MAT (Non Slit)	IS07-9613
CAP MAT (Slit)	IS07-9614

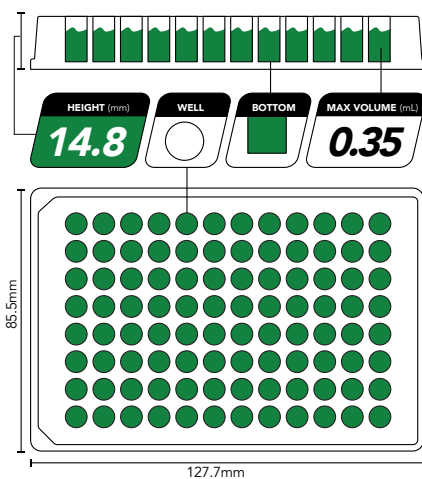

P/N: /100	PCH-RV300-0.36ML
WORKING VOLUME	0.36mL
MATERIAL	Polypropylene
SHAPE	ROUND
BOTTOM	V
W. DEPTH (mm)	11.1
W. DIAMETER (mm)	7
CAP MAT (Non Slit)	IS07-9613
CAP MAT (Slit)	IS07-9614

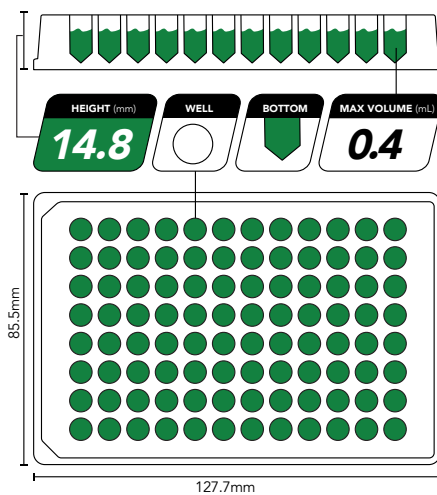

SHALLOW WELL ASSAY & STORAGE PLATES

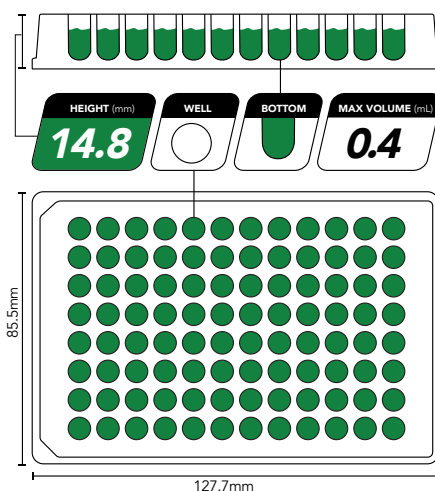

P/N: /100	PCH-RU302-0.4ML
WORKING VOLUME	0.4mL
MATERIAL	Polypropylene
SHAPE	ROUND
BOTTOM	U
W. DEPTH (mm)	11.1
W. DIAMETER (mm)	7
CAP MAT (Non Slit)	IS07-9613
CAP MAT (Slit)	IS07-9614

SEED GENOMIC PLATE

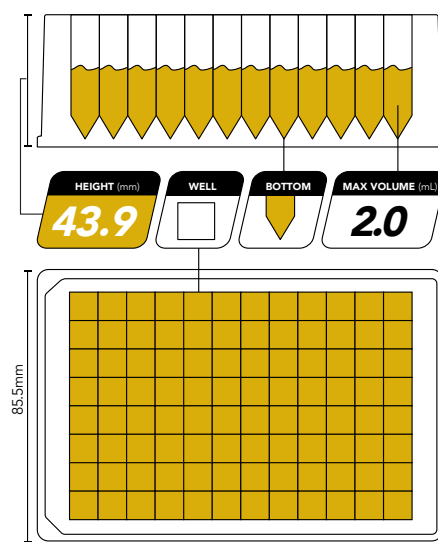

- Extraction and homogenization of phytomaterials such as seed, leaves and tissues
 - Cannabis – grinding and extraction of THC/CBD from plant material
 - Sample preparation for Plant and Seed samples prior to genomic analysis
- Designed to withstand demanding applications using steel ball bearings in the wells shaken at up to 1500 RPM used to homogenise seeds, leaves or tissue ready for DNA extraction.
- Manufactured from superior grade, ultra-clean polypropylene
- Seed Genomics plates are certified DNA/RNA and DNA/RNase free and can be paired with a matching cap mat.

P/N: /50	PCH-SVSG-2.0ML
MAX VOLUME	2.0mL
MATERIAL	Polypropylene
SHAPE	SQUARE
BOTTOM	V
W. DEPTH (mm)	N/A
W. DIAMETER (mm)	N/A
CAP MAT (Non Slit)	IS07-9611
CAP MAT (Slit)	IS07-9612

MAGNETIC 96 WELL PLATE

• Magnetic Separation Technology

Magnetic 96-Well Plate is designed for magnetic separation technology, which is used for the filtration of proteins as well as for DNA extraction.

The technology is based on magnetic particles that allow the fast and efficient sample preparation with high throughput.

Suitable for:

KingFisher™ 96 Flex Magnetic Particle Processors

Qiagen: Bio Sprint 96

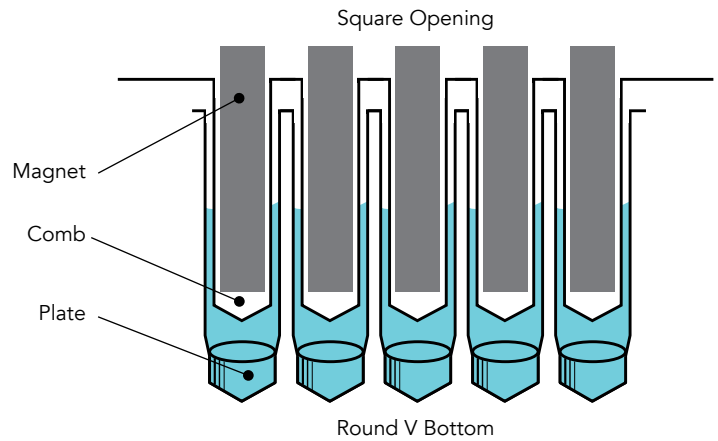

P/N: /50	RT96PPCOMB
MATERIAL	Polypropylene
SHAPE	ROUND (SQUARE OPENING)
BOTTOM	V

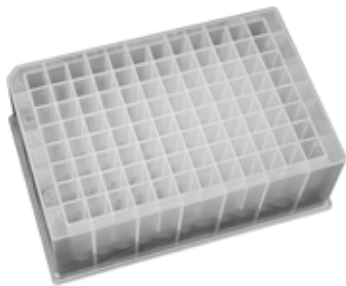
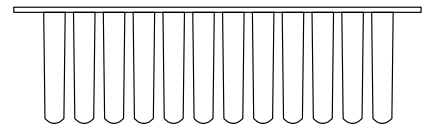

P/N: /50	RT96SRW2.0ML
MAX VOLUME	2.0mL
MATERIAL	Polypropylene
SHAPE	ROUND (SQUARE OPENING)
BOTTOM	V
W. DEPTH (mm)	N/A
W. DIAMETER (mm)	N/A
CAP MAT (Non Slit)	IS07-9611
CAP MAT (Slit)	IS07-9612

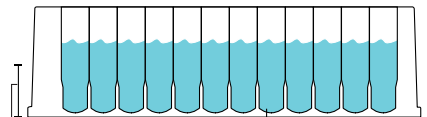

HEIGHT (mm)	WELL	BOTTOM	MAX VOLUME (mL)
43			2.0

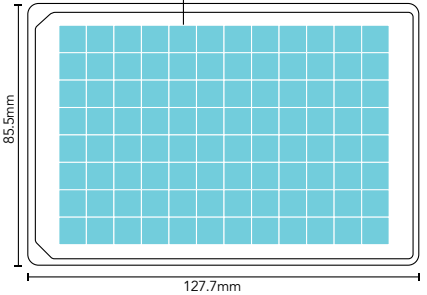

P/N: /50	RT96SRW200UL
MAX VOLUME	200µL
MATERIAL	Polypropylene
SHAPE	ROUND (SQUARE OPENING)
BOTTOM	V
W. DEPTH (mm)	N/A
W. DIAMETER (mm)	N/A
CAP MAT (Non Slit)	IS07-9611
CAP MAT (Slit)	IS07-9612

HEIGHT (mm)	WELL	BOTTOM	MAX VOLUME (mL)
14.8			0.2

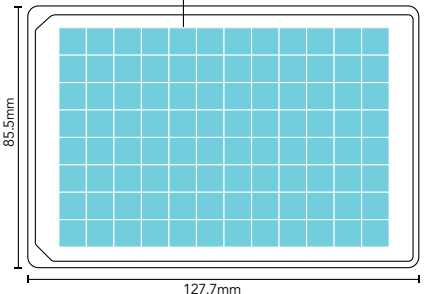

SHALLOW WELL, SEED GENOMIC & MAGNETIC ASSAY & STORAGE PLATES

384 WELL PLATES, REAGENT RESERVOIRS & INSERTS



P/N:	PCH-SV384300UL (50)	RT384PPSV200UL (40)	RT384PPSV120UL (60)
MATERIAL	Polypropylene	Polypropylene	Polypropylene
WORKING VOLUME	240µL	200µL	120µL
SHAPE	SQUARE	SQUARE	SQUARE
BOTTOM	V	V	V
HEIGHT (mm)	26	24	14
W. DEPTH (mm)	22	18	12
W. DIAMETER (mm)	3.6	3.6	3.6
CAP MAT	See Plate Seal Guide		

384 ROUND WELL PLATES





P/N: /100	RT384PPRF60UL	RT384PSRF60UL	RT384PSRF60ULW	RT384PSRF60ULBL
MATERIAL	Polypropylene	Polystyrene	Polystyrene	Polystyrene
WORKING VOLUME	50µL	50µL	50µL	50µL
BOTTOM	Flat	Flat	Flat	Flat
HEIGHT (mm)	12.6	12.6	12.6	12.6
COLOUR	Transparent	Clear	White	Black
CAP MAT	See Plate Seal Guide			



P/N: /100	RT384PSRF30UL	RT384PSRF30ULW	RT384PSRF30ULBL
MATERIAL	Polystyrene	Polystyrene	Polystyrene
WORKING VOLUME	40µL	40µL	40µL
BOTTOM	V	V	V
HEIGHT (mm)	13.2	13.2	13.2
COLOUR	Clear	White	Black
CAP MAT	See Plate Seal Guide		

REAGENT RESERVOIRS

		
P/N: /50	PCH-RES351-15ML	PCH-RES350-22ML
MATERIAL	Polypropylene	Polypropylene
DESCRIPTION	12 Channel Reservoir	8 Channel Reservoir
MAX VOLUME	14.8mL	22.1mL
CHANNEL BASE SHAPE	V	V
HEIGHT (mm)	31.4	31.4

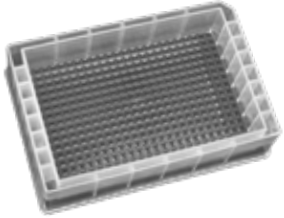
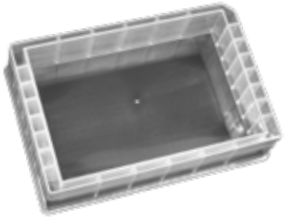
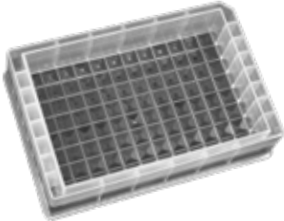
			
P/N: /50	PCH-RES353-175ML	PCH-RES355-190ML	PCH-RES352-195ML
MATERIAL	Polypropylene	Polypropylene	Polypropylene
DESCRIPTION	384 Well Reservoir	190mL Reservoir	96 Well Reservoir
MAX VOLUME	175.5mL	190mL	195mL
CHANNEL BASE SHAPE	V	Flat	V
HEIGHT (mm)	31.4	31.4	31.4

96 WELL INSERT VIAL & CAP KITS

			
	VI008-4608	VI008-4608A	VI008-4608AS *Silanized
	C250S-08S	VI008-C250S	VI008A-C250S
	C251S-08S	VI008-C251S	VI008AS-C251S

96 WELL PLATE CAP MATS

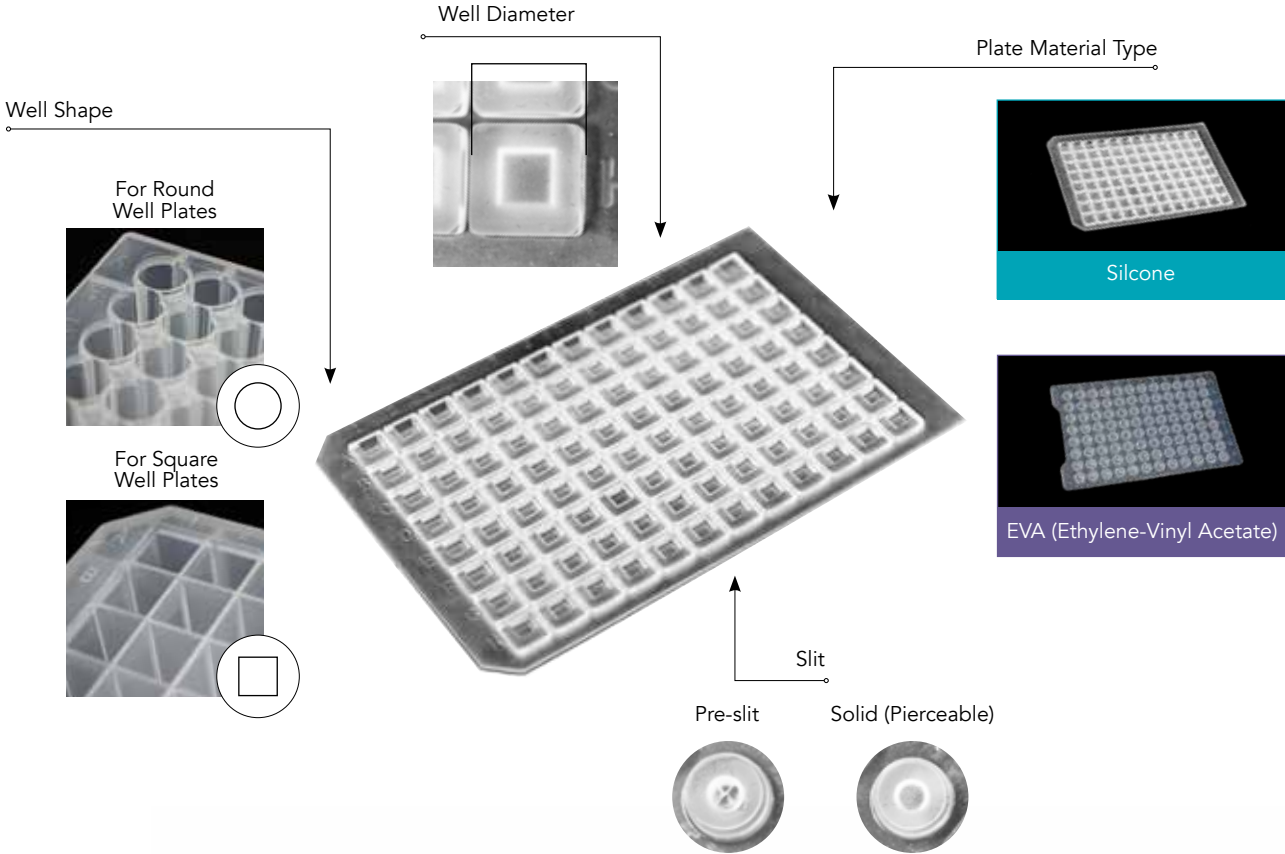

SILICONE CAP MATS

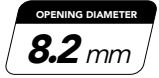
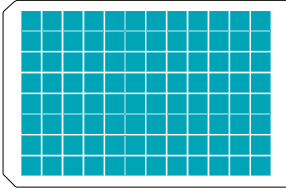
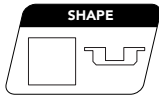

P/N: /5	IS07-9611
MATERIAL	Clear Silicone
SHAPE	Square
OPENING DIAMETER	8.2mm
SLIT	

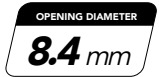
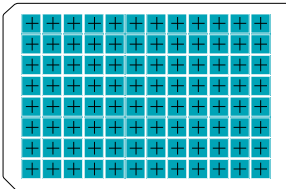
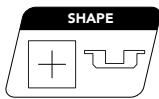
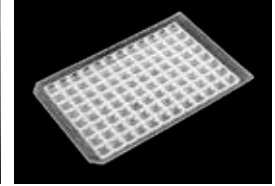

P/N: /5	IS07-9612
MATERIAL	Clear Silicone
SHAPE	Square
OPENING DIAMETER	8.4mm
SLIT	•

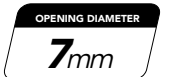
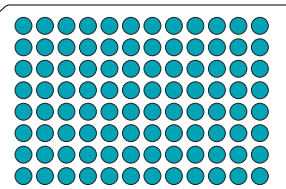
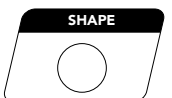
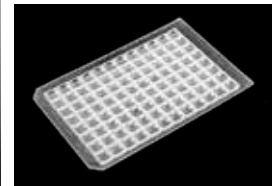

P/N: /5	IS07-9613
MATERIAL	Clear Silicone
SHAPE	Round
OPENING DIAMETER	7mm
SLIT	

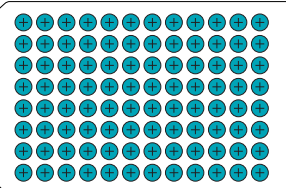
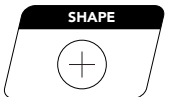
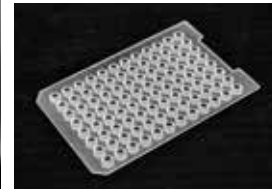

P/N: /5	IS07-9614
MATERIAL	Clear Silicone
SHAPE	Round
OPENING DIAMETER	7mm
SLIT	•

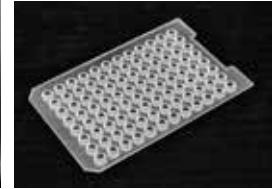
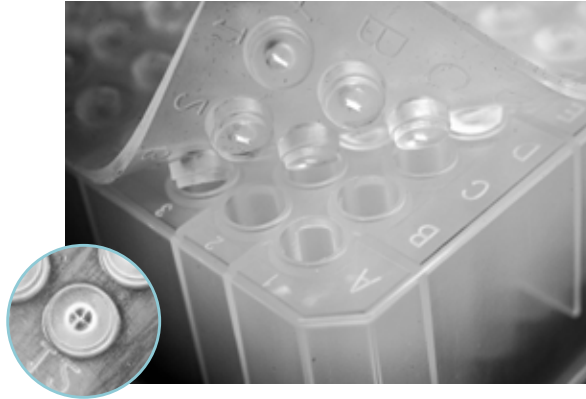

96 WELL PLATE CAP MATS

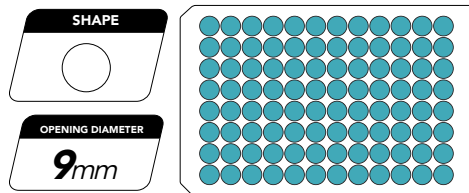

P/N: /5	IS07-9913
MATERIAL	Clear Silicone
SHAPE	Round
OPENING DIAMETER	9mm
SLIT	•

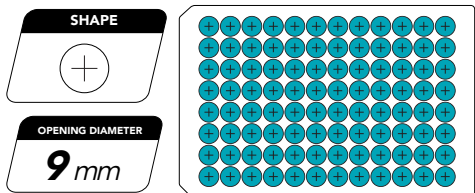
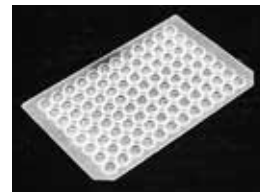

P/N: /5	IS07-9914
MATERIAL	Clear Silicone
SHAPE	Round
OPENING DIAMETER	9mm
SLIT	•

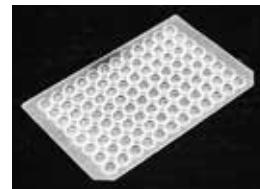

EVA CAP MATS

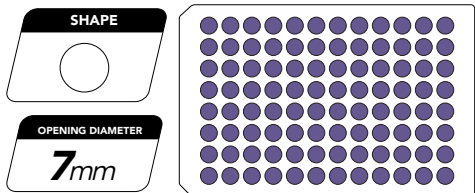

P/N: /20	RT96EVARW1ML
MATERIAL	EVA (Ethylene-Vinyl Acetate)
SHAPE	Round
OPENING DIAMETER	7mm

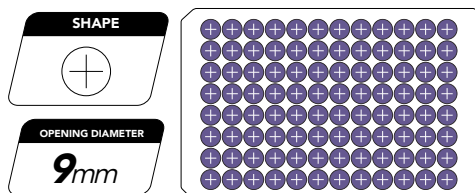
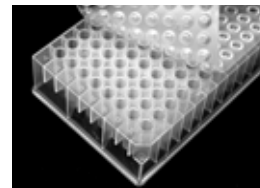
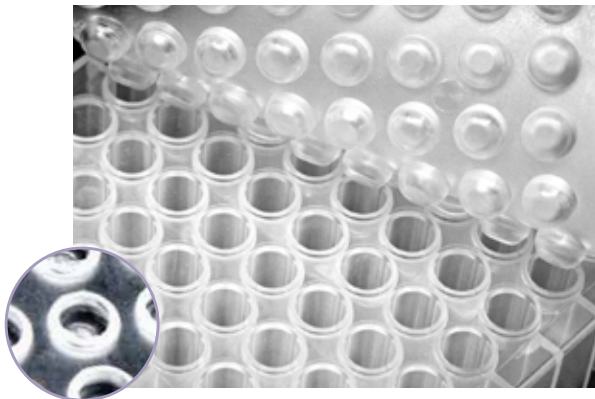

P/N: /20	RT96EVARW2ML
MATERIAL	EVA (Ethylene-Vinyl Acetate)
SHAPE	Round
OPENING DIAMETER	9mm

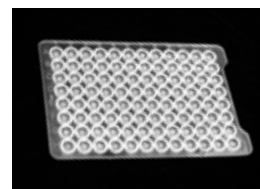
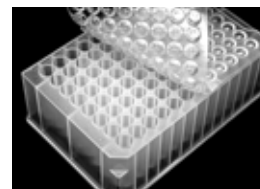
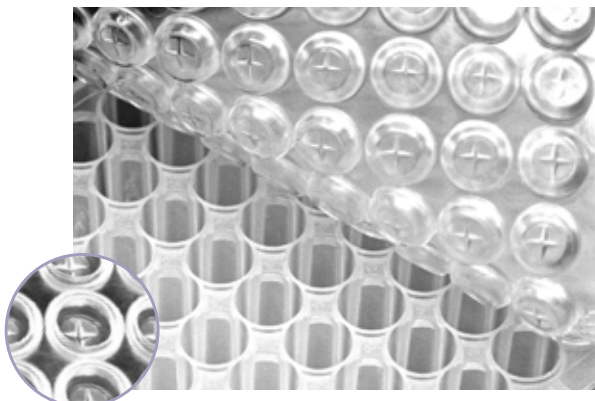

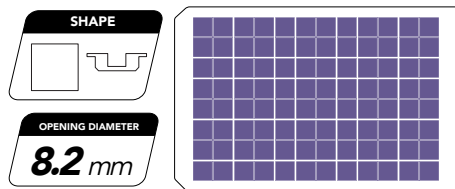

P/N: /20	RT96EVASW2ML
MATERIAL	EVA (Ethylene-Vinyl Acetate)
SHAPE	Square
OPENING DIAMETER	8.2mm

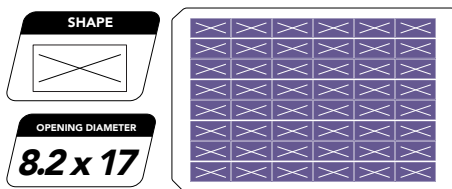
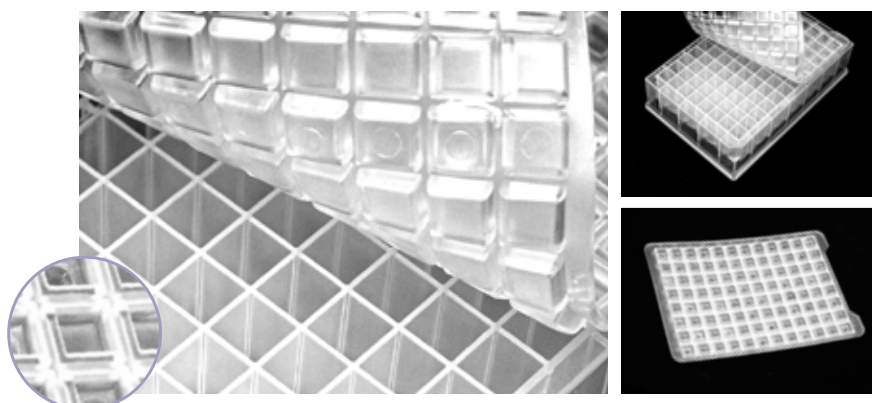

P/N: /20	RT96EVASW5ML
MATERIAL	EVA (Ethylene-Vinyl Acetate)
SHAPE	Square
OPENING DIAMETER	8.2mm x 17mm

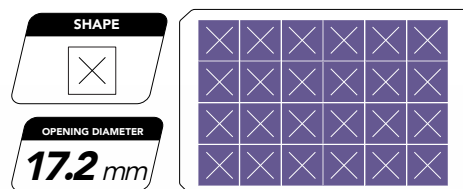
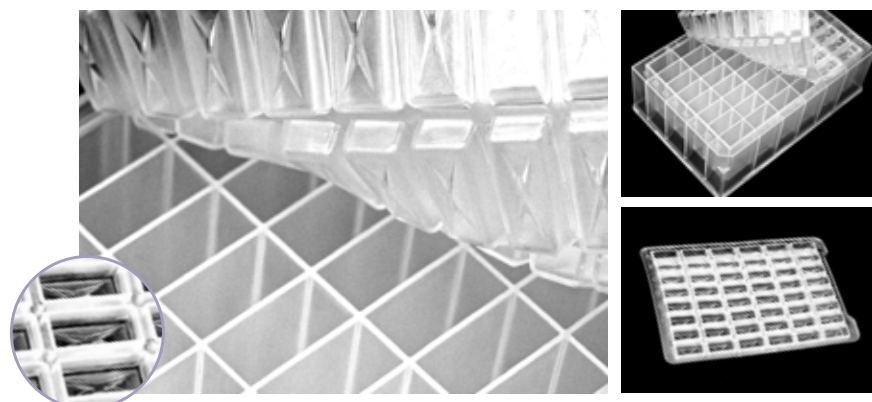

P/N: /20	RT96EVASW10ML
MATERIAL	EVA (Ethylene-Vinyl Acetate)
SHAPE	Square
OPENING DIAMETER	17mm

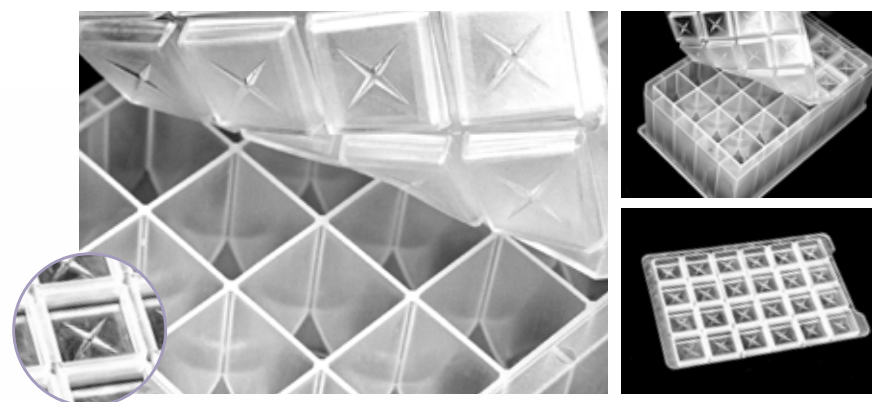

PLATE SEAL SELECTION GUIDE

Applications	Characteristics	Seal Type	Material	Size
Automation	<ul style="list-style-type: none"> -40C to 90C Pre-cut "X" over well enables piercing Allow easy sampling by probes or tips without fouling or coring Reseal for continued sample protection after sampling Printed alpha-nums provide clear identification of each well 	Adhesive Seal	Vinyl	SBS
Pierceability & Autosampling	<ul style="list-style-type: none"> -40C to 90C i. Clear zone above each well is free of adhesive and easily pierceable ii. Clear zones and end tabs facilitate well alignment and accurate positioning iii. Inert, chemical resistant Adhesive-free zones prevent adhesive fouling of pipet tips and probes Minimizes the amount of adhesive that comes into contact with the sample 	Adhesive Seal	Polypropylene	SBS
Elisa, Incubation & Storage	<ul style="list-style-type: none"> -40C to 120C Eliminate "edge effects" in sensitive ELISA assays Minimizes evaporation, prevents spillage and contamination between wells Marginally pierceable with a single-channel pipettor or probe Minimal adhesive residue on plate upon removal 	Adhesive Seal	Polyester	SBS
				SBS
	<ul style="list-style-type: none"> -40C to 120C Eliminates "edge effects" in sensitive ELISA assays Minimizes evaporation, prevents spillage and contamination between wells Available in 2x8 well strips for sealing only one or two 8-well rows at a time 	Adhesive Seal	Polyester	Strips
	<ul style="list-style-type: none"> -40C to 90C Precision cut to a smaller dimension for sealing one PCR 8-tube strip or a single row of a 96-well plate Removes easily with no splash back as can occur with strip-caps Certified DNase- & RNase- free Features an extra strong, thick adhesive to minimize evaporation Easily pierceable by robotic probes and pipet tips Inert, chemical resistant Two removable end tabs for easy positioning on microplates <p>*(SE-PP-STRIP8-AD-NS & S are not pierceable or chemical resistant)</p>	Adhesive Seal	Polyethylene	SBS
			Polypropylene	Strips

Sterile	Description	P/N#	REFERENCE
	Vinyl Seal, Pre-slit, Adhesive, Not Sterile	SE-VI-SEALX-AD-NS	N23
•	Vinyl Seal, Pre-slit, Adhesive, Sterile	SE-VI-SEALX-AD-S	
	Polypropylene Seal, Zone Free, Adhesive, Not Sterile	SE-PP-SEALZF-AD-NS	N23
	Polyester Seal, Thin, Adhesive, Not Sterile	SE-PET-SEALTH-AD-NS	N24
•	Polyester Seal, Thin, Adhesive, Sterile	SE-PET-SEALTH-AD-S	
	Polyester Seal, Adhesive, Not Sterile, Assorted	SE-PET-SEAL-AS-AD-NS	
	Polyester Seal, Adhesive, Not Sterile, Blue	SE-PET-SEAL-BL-AD-NS	
	Polyester Seal, Adhesive, Not Sterile, Clear	SE-PET-SEAL-CL-AD-NS	
•	Polyester Seal, Adhesive, Sterile, Clear	SE-PET-SEAL-CL-AD-S	
	Polyester Seal, Adhesive, Not Sterile, Green	SE-PET-SEAL-GR-AD-NS	
	Polyester Seal, Adhesive, Not Sterile, Lavender	SE-PET-SEAL-LV-AD-NS	
	Polyester Seal, Adhesive, Not Sterile, Orange	SE-PET-SEAL-OR-AD-NS	
	Polyester Seal, Adhesive, Not Sterile, Red	SE-PET-SEAL-RD-AD-NS	
	Polyester Strips, Adhesive, Not Sterile, 2 x 8 rows, 4pcs	SE-PET-STRIP2X8-AD-NS	N24
•	Polyester Strips, Adhesive, Sterile, 2 x 8 rows, 4pcs	SE-PET-STRIP2X8-AD-S	
	Polyester Strips, Adhesive, Not Sterile, 1 x 8 rows, 8pcs	SE-PET-STRIP8-AD-NS	N22
	Polyethylene Seal, Adhesive, Not Sterile	SE-PE-SEAL-AD-NS	
•	Polyethylene Seal, Adhesive, Sterile	SE-PE-SEAL-AD-S	N23
	Polypropylene Strips, Adhesive, Not Sterile, 1 x 8 rows, 8pcs	SE-PP-STRIP8-AD-NS	
•	Polypropylene Strips, Adhesive, Sterile, 1 x 8 rows, 8pcs	SE-PP-STRIP8-AD-S	N23

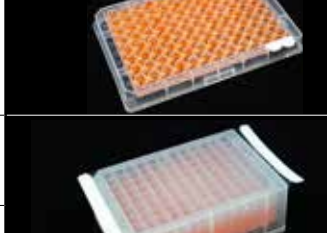
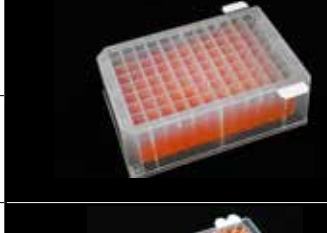
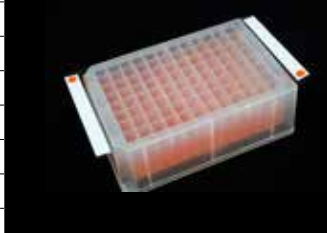
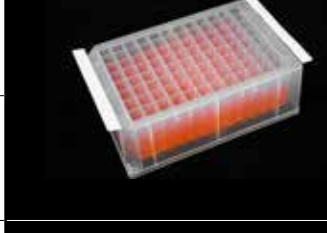
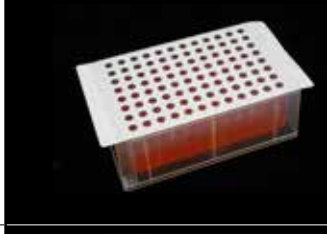
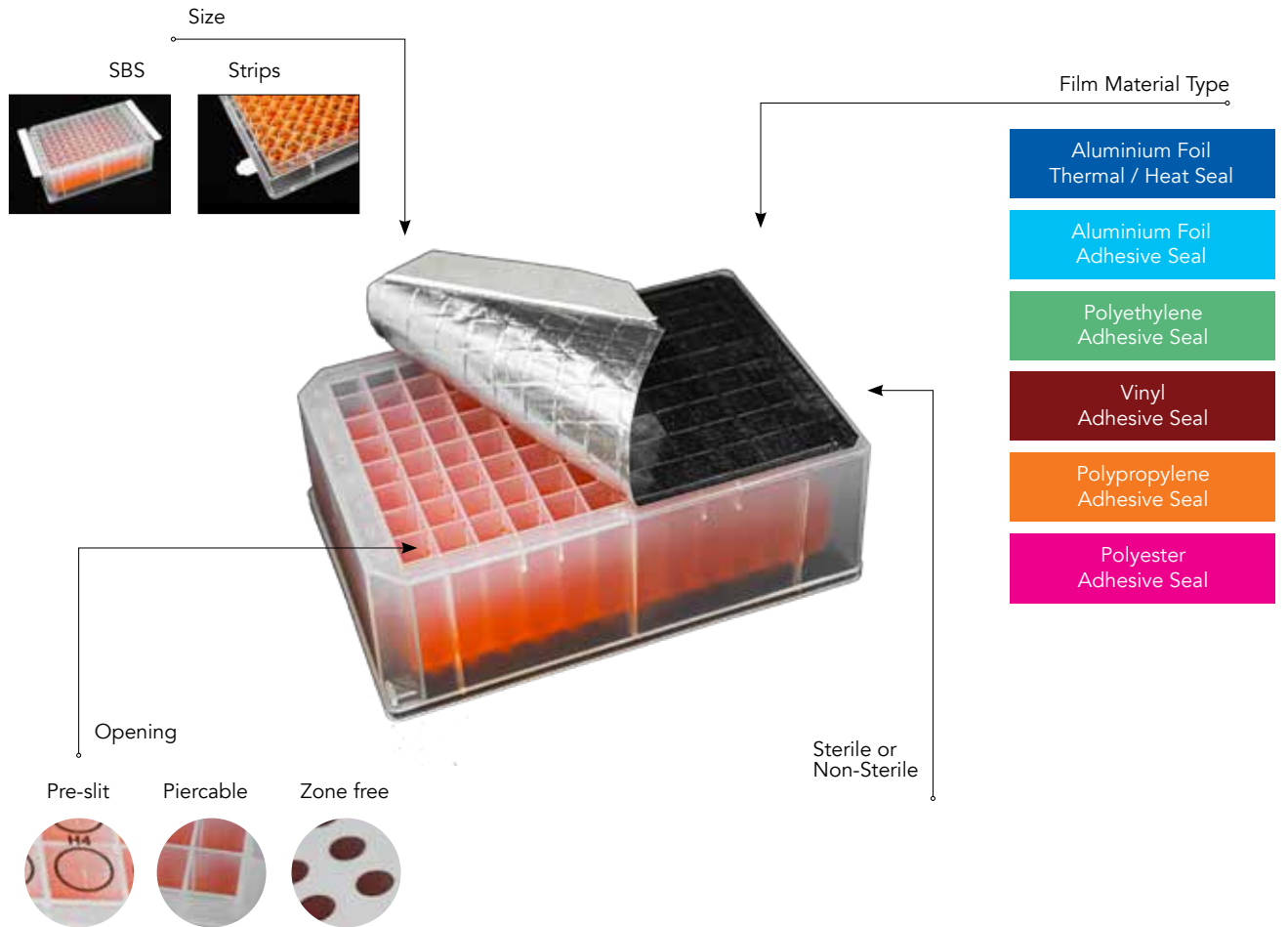

PLATE SEAL SELECTION GUIDE

Applications	Characteristics	Seal Type	Material	Size
PCR & Storage	<ul style="list-style-type: none"> -20 to 120 °C Certified Dnase & Rnase-free An extra strong, thicker adhesive minimizes evaporation and reduces well-to-well cross contamination i) SE-PET-SEAL-XAD-NS fits both raised-rim and flat top plates ii) SE-PET-SEALXL-XAD-NS fits flat top plates The smaller dimensions and chamfered corners result in no plate overhang for robotics applications Removes easily and cleanly from plate surface and will not tear upon removal 	Adhesive Seal	Polyester	SBS
PCR	<ul style="list-style-type: none"> -80 to +105C °C Better adhesion; reduced evaporation Longer end tabs for easier handling Does not tear during removal from the plate Easier to apply than aluminum foils, no tendency to roll back Certified DNase-, RNase-, and nucleic-acid-free 	Adhesive Seal	Polyester	SBS
Cold Storage	<ul style="list-style-type: none"> -20C to 120 °C Certified Dnase & Rnase-free Designed for thermal cycling and cold storage Easily pierceable with single or multichannel pipettors and robotic probes Excellent barrier properties, virtually no sample evaporation or drying 	Adhesive Seal	Aluminium Foil	SBS
		Adhesive Seal	Aluminium Foil	SBS
		Adhesive Seal	Aluminium Foil	Strips
Long-term Storage, Light Sensitive Assays and Robotics	<ul style="list-style-type: none"> -80C to 120 °C Certified Dnase & Rnase-free Excellent chemical resistance (e.g. DMSO) Excellent barrier properties minimizes sample evaporation 1.9mil thick aluminum foil minimizes shredding during removal, ideal for cold storage Conformable foil allows visual verification of seal security Pierceable with pipet tips and robotic probes for direct sample retrieval Universal fit for the use with all plate types (flat top and raised-rim) polycarbonate/polypropylene PCR plates) Removes easily and cleanly from plate surfaces and will not tear upon removal 	Adhesive Seal	Aluminium Foil	SBS
PCR, Low Temperature Storage, Transportation and Sample preparation.	<ul style="list-style-type: none"> -80° C to 120° C Resistant to DMSO and TFA as well as most other solvents Compatible with Raised rim Polypropylene plates Superior sealing performance reduces sample loss and cross contamination 	Thermal / Heat Seal	Aluminium Foil	SBS

Sterile	Description	P/N#	Image	REFERENCE
	Polyester Seal, Extra Adhesive, Not Sterile	SE-PET-SEAL-XAD-NS		N24
	Polyester Seal, Extra Large, Extra Adhesive, Not Sterile	SE-PET-SEALXL-XAD-NS		
	Polyester Thermal Seal, Adhesive, Not Sterile, Clear	SE-PET-SELPCR-CL-AD-NS		N22
	Al Foil, Adhesive, Not Sterile	SE-AL-FOIL-AD-NS		
•	Al Foil, Adhesive, Sterile	SE-AL-FOIL-AD-S		N22
	Al Strips, Adhesive, Not Sterile, 1 x 8 rows, 6pcs	SE-AL-STRIP8-AD-NS		
	Al Foil, Extra Thick, Adhesive, Not Sterile	SE-AL-FOILXT-AD-NS		N21
	Al Foil, 38µm Heat Seal (125 x 80mm)	SE-AL-SEAL-VF01-NS		

SBS PLATE SEALS



SEAL APPLICATION PADDLE

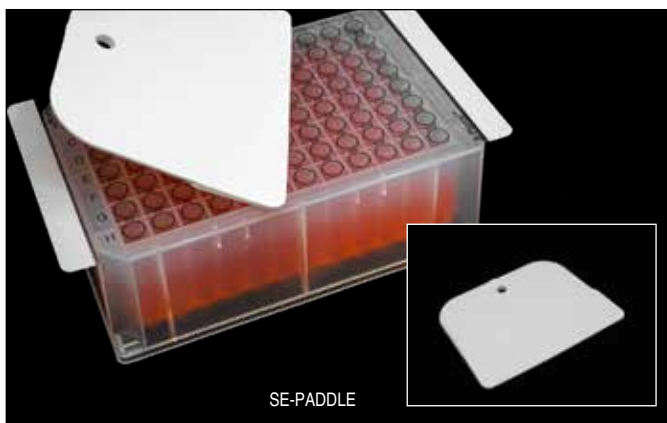

P/N	Description	Qty / Case
SE-PADDLE	Film Sealing Paddle	5

ALUMINIUM FOIL THERMAL / HEAT SEAL



P/N	Description	Qty / Case
SE-AL-SEAL-VF01-NS	Al Foil, 38µm Heat Seal (125 x 80mm)	100

ALUMINIUM FOIL ADHESIVE SEAL

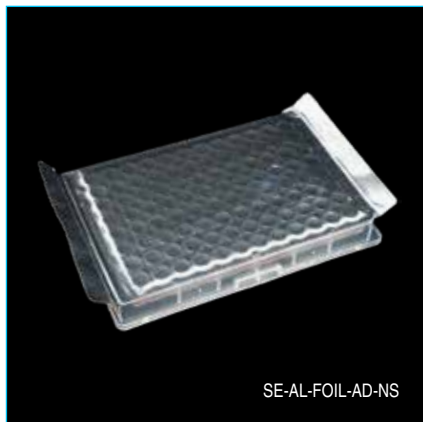

P/N	Description	Sterile	Qty / Case
SE-AL-FOIL-AD-NS	Al Foil, Adhesive		100
SE-AL-FOIL-AD-S	Al Foil, Adhesive	•	25
SE-AL-FOILXT-AD-NS	Al Foil, Extra Thick, Adhesive		100
SE-AL-STRIP8-AD-NS	Al Strips, Adhesive, 1 x 8 rows, 6pcs		300

POLYETHYLENE ADHESIVE SEAL

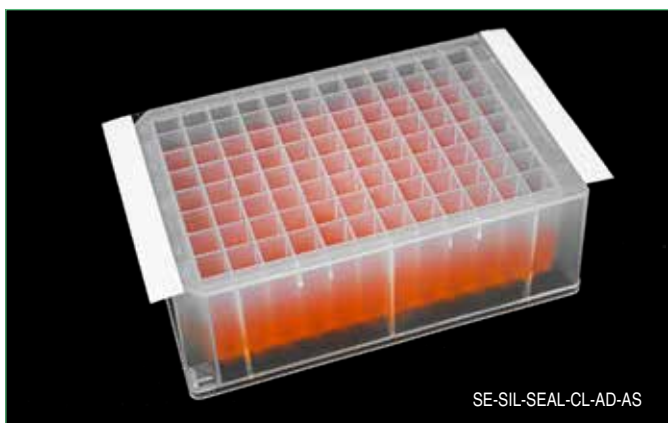

P/N	Description	Sterile	Qty / Case
SE-PE-SEAL-AD-NS	Polyethylene Seal, Adhesive		100
SE-PE-SEAL-AD-S	Polyethylene Seal, Adhesive	•	50

SBS PLATE SEALS

POLYPROPYLENE ADHESIVE SEAL



SE-PP-STRIP8-AD-NS

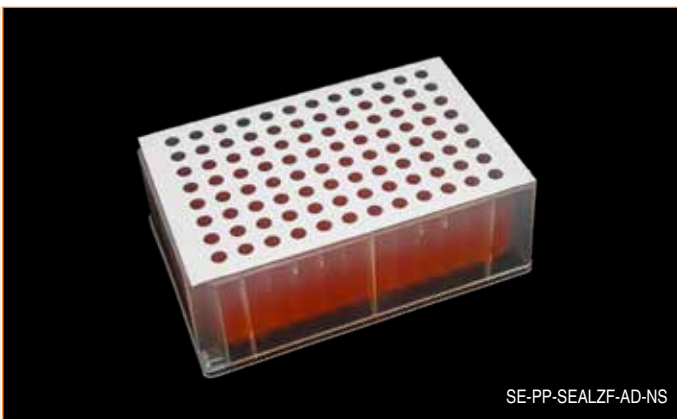

SE-PP-SEALZF-AD-NS

P/N	Description	Sterile	Qty / Case
SE-PP-STRIP8-AD-NS	PP Strips, Adhesive, 1 x 8 rows, 8pcs		400
SE-PP-STRIP8-AD-S	PP Strips, Adhesive, 1 x 8 rows, 8pcs	•	400
SE-PP-SEALZF-AD-NS	Polyethylene/Polypropylene Seal, Zone Free, Adhesive		50

VINYL ADHESIVE SEAL

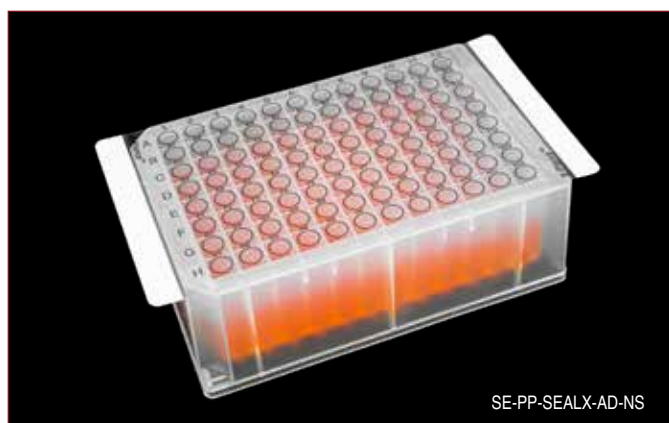

SE-PP-SEALX-AD-NS



SE-PP-SEALX-AD-NS

P/N	Description	Sterile	Colour	Qty / Case
SE-PP-SEALX-AD-NS	Vinyl Seal, Pre-slit, Adhesive		Clear	100
SE-PP-SEALX-AD-S	Vinyl Seal, Pre-slit, Adhesive	•	Clear	50

POLYESTER ADHESIVE SEAL

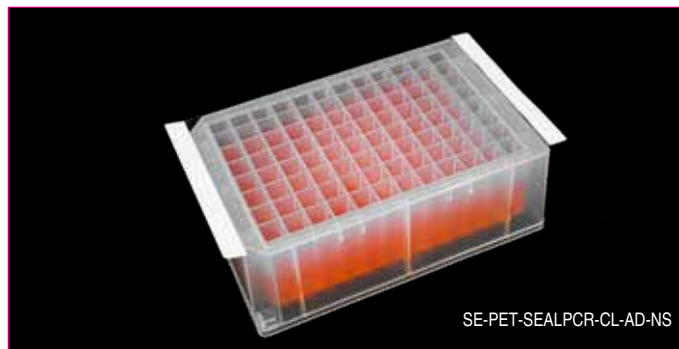

P/N	Description	Colour	Sterile	Qty / Case
SE-PET-SEALPCR-CL-AD-NS	Polyester Thermal Seal, Adhesive	Clear		100
SE-PET-SEAL-XAD-NS	Polyester Seal, Extra Adhesive	Clear		100
SE-PET-SEALXL-XAD-NS	Polyester Seal, Extra Large, Extra Adhesive	Clear		100
SE-PET-STRIP8-AD-NS	Polyester Strips, Adhesive, 1 x 8 rows, 8pcs	Clear		400
SE-PET-SEAL-CL-AD-NS	Polyester Seal, Adhesive, Clear	Clear		100
SE-PET-SEAL-CL-AD-S	Polyester Seal, Adhesive, Clear	Clear	•	100
SE-PET-SEAL-AS-AD-NS	Polyester Seal, Adhesive, Assorted	Assorted		50
SE-PET-SEAL-BL-AD-NS	Polyester Seal, Adhesive, Blue	Blue		100
SE-PET-SEAL-GR-AD-NS	Polyester Seal, Adhesive, Green	Green		100
SE-PET-SEAL-LV-AD-NS	Polyester Seal, Adhesive, Lavender	Lavender		100
SE-PET-SEAL-OR-AD-NS	Polyester Seal, Adhesive, Orange	Orange		100
SE-PET-SEAL-RD-AD-NS	Polyester Seal, Adhesive, Red	Red		100
SE-PET-STRIP2X8-AD-NS	Polyester Strips, Adhesive, 2 x 8 rows, 4pcs	Clear		200
SE-PET-STRIP2X8-AD-S	Polyester Strips, Adhesive, 2 x 8 rows, 4pcs	Clear	•	200
SE-PET-SEALTH-AD-NS	Polyester Seal, Thin, Adhesive	Clear		100
SE-PET-SEALTH-AD-S	Polyester Seal, Thin, Adhesive	Clear	•	100

VIAL SELECTION GUIDE *ALL VIALS 100% TO SCALE

ND9 SCREW TOP VIALS (12mm x 32mm)

VT009-1232	VT009A-1232	VT009M-1232	VT009M-1232A	VB309-1232	VB309-1232A	VB309M-1232	VB309M-1232A	V0159P-1232
2mL	2mL	2mL	2mL	300µL	300µL	300µL	300µL	2mL
VG309-1232	V01509-1232	V01509-1232A	CHR05100SC	CHR05100ASC	CHR095SC	CHR095ASC	CHR099SC	V0309P-1232
300µL	Res. Vol. 15µL	Res. Vol. 15µL	Res. Vol. 25µL	Res. Vol. 25µL	1.5mL	1.5mL	Res. Vol. 4µL	300µL

*Polypropylene

*Polypropylene

ND11 CRIMP TOP VIALS (12mm x 32mm)

VT011-1232	VT011M-1232A	VT011L-1232	VT011LM-1232	VT11LM-1232A	VB311C-1232	VB311MC-1232	VB311MC-1232A
2mL	2mL	2mL	2mL	2mL	300µL	300µL	300µL
VG311C-1232	V01511-1232	V01511-1232A	V1111-1232	CHR05100CR	VE062002		
300µL	Res. Vol. 15µL	Res. Vol. 15µL	Res. Vol. 15µL	Res. Vol. 25µL	Res. Vol. 4µL		

ND11 SNAP TOP VIALS (12mm x 32mm)

VT011SM-1232	VT11SM-1232A	VB311-1232	VB311M-1232	VB311MA-1232	VG311-1232	
2mL	2mL	300µL	300µL	300µL	300µL	
V01511S-1232	V01511S-1232A	CHR05100SN	VE062392	V0300P-1232	V0700P-1232	V0711P-1232
Res. Vol. 15µL	Res. Vol. 15µL	Res. Vol. 25µL	4µL	300µL	700µL	750µL

ND8 SCREW TOP VIALS (12mm x 32mm)

VT008A-1232	VT008M-1232	VT008M-1232A
2mL	2mL	2mL

ND10 SCREW TOP VIALS (12mm x 32mm)

VT010M-1232	VT010M-1232A
2mL	2mL

6MM MICRO INSERTS (LARGE OPENING)

I025-629	I025BS-629	I025-630	I025CP-631	I025GF-631	I025PBS-629*	I025PFT-629*	I025P-631*
250µL	250µL	350µL	250µL	250µL	250µL	250µL	250µL
6mm x 29mm	6mm x 29mm	6mm x 30mm	6mm x 31mm	6mm x 31mm	6mm x 29mm	6mm x 29mm	6mm x 31mm

*Polypropylene

5MM MICRO INSERTS (SMALL OPENING)

I005BS-625	I01-531	I01BS-530	I025-531	I01PBS-530*
50µL	100µL	100µL	250µL	100µL
5mm x 28mm	5mm x 31mm	5mm x 30mm	5mm x 31mm	5mm x 30mm

*Polypropylene

VIAL SELECTION GUIDE

1ML SHELL VIALS

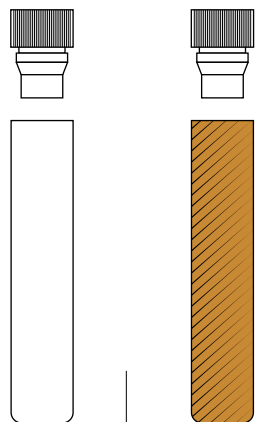

V800-840Q	V800-840AQ
1mL	1mL
8.2mm x 40mm	8.2mm x 40mm

96W INSERTS

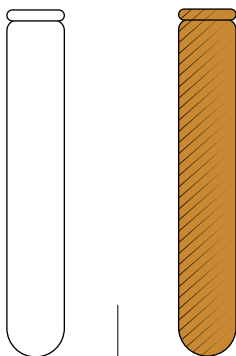

VI008-4608	VI008-4608A
1mL	1mL
7.6mm x 45.9mm	7.6mm x 45.9mm

ND8 CRIMP MICRO VIALS

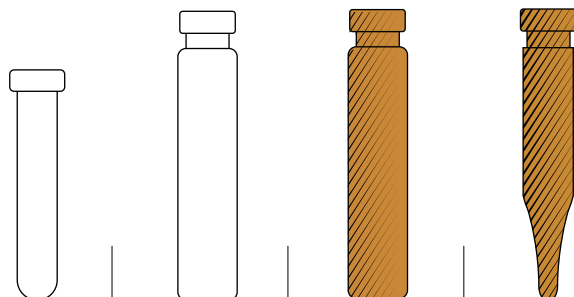

V0308-632	V0808-840	V0808A-840	V0708-840A
300µL	1.2mL	1.2mL	700µL
5.5mm x 31.5mm	8.2mm x 40mm	8.2mm x 40mm	7mm x 40mm

4ML SCREW TOP VIALS (15mm x 45mm)

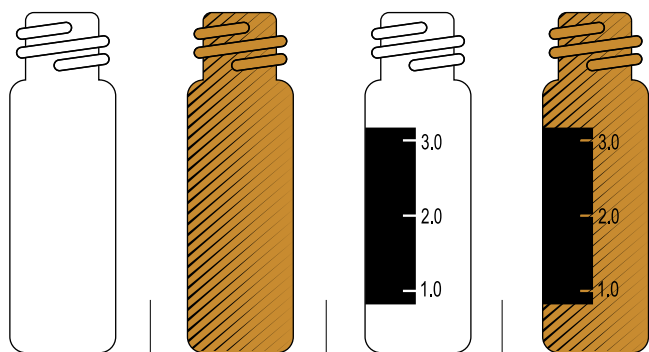

VF013-1545	VF013A-1545	VF013MM-1545	VF013MA-1545
15mm x 45mm	15mm x 45mm	15mm x 45mm	15mm x 45mm



STORAGE / DRAM VIALS

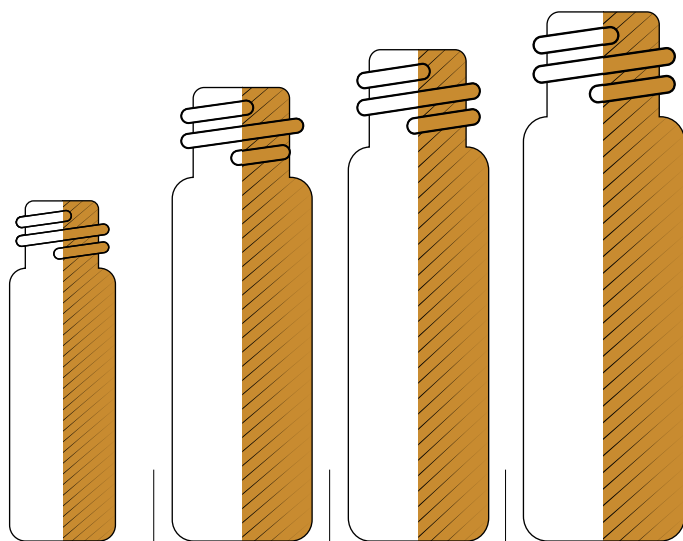

CLEAR	VF013-1545	VS015-1760X	VX2015-1965X	V16018-2170X
AMBER	VF013A-1545	VS015A-1760X	VX2015A-1965X	V16018A-2170X
VOLUME	4mL / 1 Dram	7mL / 2 Dram	10mL / 3 Dram	15mL / 4 Dram
SIZE	15mm x 45mm	17mm x 60mm	19mm x 65mm	21mm x 70mm

SCREW TOP HS VIALS

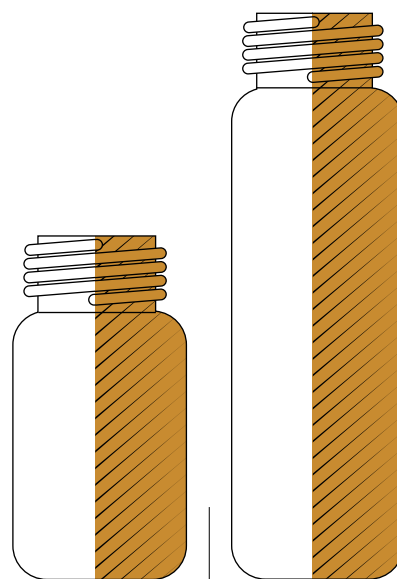

CLEAR	VX0018-2346S	VXX018-2375S
ROUND BOTTOM	VX0018-2346CTC	VXX018-2375CTC
AMBER	VX0018A-2346S	VXX018A-2375S
VOLUME	10mL	20mL
SIZE	23mm x 46mm	23mm x 75mm

CRIMP TOP HS VIALS



CLEAR	V06020-2338X		VX0020-2346X	VXX0020-2375X	VXX020-2375CTC	VX0020-2346CTC	VXX020PE-2375
AMBER		VX0020AB-2346X		VXX0020A-2375X			
VOLUME	6mL	10mL	10mL	20mL	20mL	10mL	20mL
SIZE	21.75mm x 38mm	23mm x 46mm	23mm x 46mm	23mm x 75mm	23mm x 75mm	23mm x 46mm	23mm x 75mm

NEW SECTIONS COMING SOON!
SAMPLE PREP • GC COLUMNS
For Chrom4 Complete Chromatography Catalogue



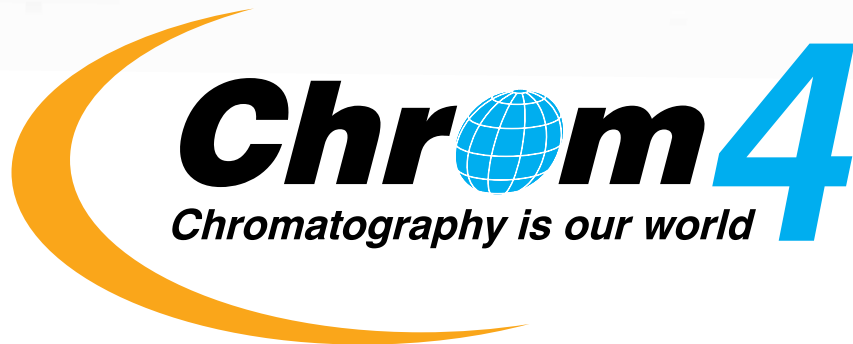

www.chrom4.com